

**STONE TOWN COUNCIL**

**Town Clerk**

Les Trigg

15 Station Road  
Stone  
ST15 8JP

**Tel: 01785 619740**

**Fax: 01785 619741**

21 December 2017

A meeting of the **TOURISM & TOWN PROMOTION SUB COMMITTEE** will be held in **St Michael's Suite at the Frank Jordan Centre, Lichfield Street, Stone, on TUESDAY 9 JANUARY 2018 at 7.05 pm** or on the rising of the Planning Committee if later.

I trust you will be able to attend.

Les Trigg  
Town Clerk

Councillors: I. Fordham (Chair), Mrs J. Hood (Vice Chair), P. Leason, Mrs K. Green, Mrs J. Piggott, M. Williamson and Mrs C. Collier.

Co-opted: Mr J Heal

**AGENDA**

1. **To receive apologies for absence**
2. **Declarations of Interest and Requests for Dispensations Received**
3. **Representations from Members of the Public**

To consider representations from members of the public on items to be considered at this meeting, in accordance with the Council's scheme of public participation

4. **Train Service Update**

To receive updates from Mr Jon Heal

5. **Stone Town Centre Development Strategy**

To receive a report from the Chairman of the Sub-Committee and working groups:

- Town Centre Appearance and Environment Working Group
- Town Centre Events and Attractions Working Group
- 'Town Centre Partnership'

6. **Budgets 2018-19 to 2020-21**

To consider the report of the Town Clerk (attached)

7. **Visit Staffordshire Subscription**

To receive a verbal report from the Chairman of the Sub-Committee

8. **Arrangements to Celebrate the Centenary of the Formation of the Royal Air Force**

Item for discussion

9. **Battles Over – A Nation's Tribute**

Following the Council's decision to take part in the lighting of beacons, a further request has been received to ask the Council to arrange with local churches to ring bells as part of the event (email attached).

10. **Update from Working Groups**

- Commemoration to mark 100 years since the end of World War 1 in 2018

Please note that other working group reports are considered under item 5

Members of the public are welcomed to attend the Tourism & Town Promotion Sub-Committee Meeting as observers and/or to make representations to the committee in accordance with the Council's scheme of public participation. Details of this scheme are displayed in the Council's notice boards and are also available from the Town Council.

**Stone Town Council – Tourism & Town Promotion Sub-Committee**

**9<sup>th</sup> January 2018**

**Tourism and Town Promotion Sub-Committee Budget 2018-19 to 2020-21**

**Report of Town Clerk**

**Introduction**

1. The purpose of this report is to determine the level of budget for services under its control that the Sub-Committee wishes to recommend to the General Purposes Committee meeting on 23<sup>rd</sup> January 2018.

**Background**

2. The General Purposes Committee on 5<sup>th</sup> December 2017 considered the standstill budget for 2018-19 and indicative figures for the next two years based on a number of assumptions contained within the report.
3. The figures for this Sub-Committee are:

<b>Actual 2016-17 £</b>		<b>Budget 2017-18 £</b>	<b>Forecast 2017-18 £</b>	<b>Budget 2018-19 £</b>	<b>Budget 2019-20 £</b>	<b>Budget 2020-21 £</b>
13,768	Christmas Lights	15,000	13,300	15,000	15,500	15,900
636	Advertising	500	700	700	700	700
18,880	Tourism & Town Promotion	21,600	21,200	21,500	21,100	21,700
<hr/> <b>33,284</b> <hr/>	<b>TOTAL</b>	<hr/> <b>37,100</b> <hr/>	<hr/> <b>35,200</b> <hr/>	<hr/> <b>37,200</b> <hr/>	<hr/> <b>37,300</b> <hr/>	<hr/> <b>38,300</b> <hr/>

4. In respect of the figures above, Members should note:
  - a. The Christmas Lights budget includes the cost of providing the lights, and the electricity to run them, but not the costs of the switch-on event which are included in this Committee's Tourism & Town Promotion budget. The budget reflects the agreed contract payments to Christmas Plus together with a contingency for maintenance and replacement of the infrastructure and Council owned lights.
  - b. The Advertising budget is currently being used for one advertisement per year in the Stone Festival edition of the Gazette. This has been continued into future years.
  - c. The Tourism and Town Promotion budget includes provision for hanging baskets throughout the town centre (£5,000), the Christmas lights switch-on event (£3,000), a provision towards a World War One event in 2018 (£1,000 up to 2018-19 only) and a general contingency for town promotion events, including the Music Festival (£11,900). Inflation is also added to these figures.

5. As reported to the meeting of the General Purposes Committee on 5<sup>th</sup> December, the standstill budget is just the starting point for the budget process. Members will want to review this standstill budget and the amounts provisionally included. In addition, there are likely to be other areas where Members will want to undertake new developments or stop/change the things that the Council is doing now.
6. The Sub-Committee is asked to consider the standstill budget and any areas of growth or savings which they would want to be taken into account in setting the budget for 2018-19 and future years.

### **Recommendations**

7. Members are asked to recommend their proposed budget for consideration by the General Purposes Committee on 23<sup>rd</sup> January 2018.

## Trudy Williams

---

**From:** Bruno Peek <brunopeek@mac.com>  
**Sent:** 19 October 2017 17:24  
**To:** events@n-somerset.gov.uk; Jackie Allen; Deb and Pete Nicholson;  
nick.burton@lichfield.gov.uk; finance@rugeleytowncouncil.gov.uk;  
peter@littlestokefarm.fsnet.co.uk; Katiembey@cannockchasedc.gov.uk; arnold384  
@btinternet.com; loggerheadspc@btconnect.com; martyn\_hordern@hotmail.com;  
chair@dilhorne-recreation-centre.com; susanmckeown21@gmail.com;  
andy.cooper@colwichparishcouncil.gov.uk  
**Subject:** Fwd: BATTLE'S OVER - A NATION'S TRIBUTE 11TH NOVEMBER 2018 UPDATE  
**Attachments:** Battle's Over Guide v14.pdf

Dear Participants,

RE: EARLY UPDATE & NEW GUIDE TO TAKING PART IN 'BATTLE'S OVER - A NATION'S TRIBUTE 11TH NOVEMBER 2018'.

We were due to update you in JANUARY NEXT YEAR. However, the new Guide To Taking Part has been completed early, outlining the whole days activities - (PLEASE SEE ATTACHED GUIDE),

From the Guide, you will now see all the four elements relating to 'Battle's Over' on 11th November 2018:

6.00AM: 'Sleep in peace, now the battle's over' - 6.55PM: 'Battle's Over - The Last Post' - 7.00PM: 'WWI Beacons of Light' - 7.05PM: 'Battle's Over - Ringing out for peace'.

With regard to Battle's Over - Ringing out for peace, we would be delighted if you would approach your local Cathedral/Minster/Churches encouraging them to take part by ringing their bells at 7.05pm to help us achieve the sound of thousands of bells ringing across our nation that night. Our overall aim is to have 1000 Cathedrals/Minsters/Churches involved, so would be extremely grateful if you would approach them as soon as possible, asking those wishing to take part, to email us the following information by no later than the 31ST OCTOBER 2018 please, to ensure we list them in the Guide during it's three monthly update taking place every three months from the 31st October 2017, through to 31ST OCTOBER 2018. Please ask them to send the details below to [brunopeek@mac.com](mailto:brunopeek@mac.com)

Name of Cathedral/Minster/Church etc:

Address:

Country:

County:

Name of contact:

Telephone number:

Email address:

From page 2 of the Guide, you will see the special certificate produced for this occasion to enable participants to download it from 30TH NOVEMBER 2018, so you/they can print it off and frame it as a permanent reminder of your/their involvement in this unique day of commemoration.

Please be kind enough to ensure you have undertaken all the elements relating to page 13, to ensure a safe and enjoyable event on 11th November 2018. We will send you an outline press release during OCTOBER 2018, so you can localise it regarding your event, before YOU send it to all your contacts within your local media to ensure they are aware of your involvement in this unique tribute. (Please plan around distributing this press release on FRIDAY 2ND NOVEMBER 2018). Our next update to you will be in JULY 2018.

However, in the meantime, may I take this opportunity to pass on my warmest best wishes and to thank you once again for your amazing support and involvement, and wish you well with your planning.

Bruno

Bruno Peek LVO OBE OPR

Pageantmaster

Battle's Over - A Nation's Tribute

Tel: + 44 (0) 7737 262 913

# BATTLE'S OVER



A NATION'S TRIBUTE

11TH NOVEMBER 2018

100 YEARS OF REMEMBRANCE



*March no more my soldier laddie,  
There is peace where there once was war.  
Sleep in peace my soldier laddie,  
Sleep in peace, now the battle's over.*

YOUR GUIDE TO TAKING PART



**BATTLE'S  
OVER**

A NATION'S TRIBUTE  
11TH NOVEMBER 2018  
100 YEARS OF REMEMBRANCE

*Certificate of Grateful Recognition  
11th November 2018*

With sincere thanks for your contribution to Battle's Over,  
the international commemoration of the centenary  
of the end of World War I.

In association with:  
The Society of Editors, Army Cadet Force, Air Training  
Corps, Sea Cadet Corps, Combined Cadet Force,  
Association of English Cathedrals, Merchant Navy  
Association, Royal Naval Association, ABF The Soldiers'  
Charity, Royal Air Force Benevolent Fund, The  
Buglers Association of The Light Division &  
Rifles, Trinity House, National Association of  
Local Councils, National Association of Civic  
Officers, One Voice Wales, National Trust, English  
Heritage, Central Council of Bellringers, The  
College of Piping and the National Union of  
Mineworkers (formerly known as Miners Federation  
of Great Britain).

*Bruno Peek*

Bruno Peek LVO OBE OPR  
Originator & Pageantmaster  
Battle's Over - A Nation's Tribute  
11th November 2018

This certificate can be downloaded at  
**[www.brunopeek.co.uk](http://www.brunopeek.co.uk)** from 30th  
November 2018 to enable participants to  
print it off and frame it as a permanent  
reminder of their involvement in this  
unique tribute.





# Contents

**Page 4**  
Introduction

**Page 6**  
Sleep in peace, now the battle's over

**Page 7**  
History of the Last Post - 'The People's Anthem'

**Page 8**  
The History of Church Bell ringing

**Page 9**  
How to take part  
& Beacon Lighting Ceremony

**Page 10**  
WWI Beacons of Light,  
your unique gas-fuelled Beacon

**Page 11**  
WWI Beacons of Light,  
Beacon Brazier

**Page 12**  
WWI Beacons of Light,  
Bonfire Beacon

**Page 13**  
Your responsibility,  
Legal Essentials and Safety

**Page 14**  
Message from the First Sea Lord Admiral Sir Philip Jones  
KCB ADC  
Chief of Naval Staff

**Page 16**  
Message from General Sir Nicholas Patrick Carter  
KCB CBE DSO ADC Gen  
Chief of the General Staff

**Page 18**  
Message from the Air Chief Marshal Sir Stephen Hillier  
KCB CBE DFC ADC MA RAF  
Chief of the Air Staff

**Page 20**  
Message from Captain John Sail - National Chairman,  
The Merchant Navy Association

**Page 22**  
Battle's Over - A Nation's Tribute  
& WWI Beacons of Light  
Chosen Charities

**Page 23**  
Acknowledgements



# Introduction

## BATTLE'S O V E R



A NATION'S TRIBUTE

11TH NOVEMBER 2018

100 YEARS OF REMEMBRANCE

*Your chance to pay your  
personal and community  
tribute to those millions  
that gave their lives  
for their country  
or returned home wounded  
during or after the dreadful  
darkness of four years of War  
1914 - 1918*

**On 11th November 2018, the United Kingdom and its friends overseas will mark the day 100 years ago when the guns fell silent at the end of the First World War.**

You can play your part in remembering the sacrifice of millions of men and women by joining us in Battle's Over, a unique series of events in the morning and evening involving organisations and communities the length and breadth of our nation and in many countries abroad.

- **Battle's Over - Sleep in peace, now the battle's over**
- **Battle's Over - The Last Post**
- **Battle's Over - WWI Beacons of Light**
- **Battle's Over - Let the Bells Ring Out**

### **6.00am - Battle's Over - Sleep in peace, now the battle's over**

The sound of 1,000 bagpipes will fill the air before dawn has broken on 11th November 2018. In cities and towns throughout the land individual pipers will play Battle's O'er - a traditional air played by pipers after a battle. heralding the start of the day's commemorations, they will play the haunting tune outside churches and cathedrals, in market squares and muddy fields, on hilltops and high streets, in valleys and village greens throughout the United Kingdom, Channel Islands and the Isle of Man, and at scores of locations overseas, including Australia, Canada, the USA, Germany, South Africa, France, Spain, Denmark, Israel and Somalia to name but a few.

A lone piper will play Battle's O'er in front of the Tomb of the Unknown Warrior at Westminster Abbey, London, with others undertaking a similar performance in front of cathedrals in the UK. At the same time, pipers everywhere will be playing the same tune in their local communities.

Following the playing of this piece of music at the Merchant Navy Associations National Memorial, Trinity Square Gardens, Tower Hill, London, at 6am, through to 7pm, when a WWI Beacon of Light will be lit, the 15,000 names of those brave Merchant Navy Seamen who lost their lives during this

dreadful war will be read out by a range of people from all over the United Kingdom, in remembrance of the sacrifices made.

We anticipate that this unique tribute, organised in association with the Glasgow-based College of Piping, will start the centenary media coverage on television and radio, and will provide some of the day's most moving and atmospheric sights and sounds, so if you wish to encourage a local Piper to participate by playing Battle's O'er at a location of their choice (excluding Cathedral's), please ask them to register asap, providing the following information to:

[battlesoer@collegeofpiping.org](mailto:battlesoer@collegeofpiping.org)

**Name of Piper, Address, Country, County, Tel, Email**

### **6.55pm Battle's Over - The Last Post**

In association with the Air Training Corps, Army Cadet Force, Sea Cadet Force and the Light Infantry Buglers Association, the Last Post will be played at many of the 1,000 WWI Beacon sites throughout the United Kingdom, involving young people and others paying their personal tribute to those that gave their lives during World War I.

### **7.00pm Battle's Over - WWI Beacons of Light**

Later that day, after darkness has fallen, more than 1,000 Beacons of Light will be lit throughout the United Kingdom, Channel Islands, Isle of Man and UK Overseas Territories.

This is a commemoration inspired by a comment made on 3rd August 1914 by Britain's Foreign Minister, Sir Edward Grey. He was looking out of his office window at dusk as gas lights were being lit along London's Mall when he remarked to a friend, "The lamps are going out all over Europe; we shall not see them lit again in our lifetime."

Our country was about to be plunged into the darkness of the First World War, and it would be four long years before Britain and Europe would again experience the light of peace.



In remembrance of the end of the war and the millions who were killed or came home dreadfully wounded, Beacons of Light will be lit around the country at 7pm on 11th November 2018.

The event will also commemorate the huge army of men and women on the home front who, often in dangerous and exhausting conditions, underpinned the war effort - keeping the wheels of industry turning and bringing home the harvests. The beacons will symbolise the light of hope that emerged from the darkness of war.

Among the communities and other organisations that have confirmed their involvement are the Tan Hill Inn, Yorkshire Dales, the highest pub in Great Britain; Unst, the most northerly inhabited island in Scotland; St David's, the most westerly city in Wales; Lowestoft, Suffolk, the most easterly town in England, and St Macartin's Cathedral, Enniskillen, the most westerly location in the United Kingdom. We do hope that your council and community will also choose to take part in this historic tribute.

There are a number of cost-effective ways of participating.

- (1) Use existing beacon braziers set on tall wooden poles and gas-fuelled beacons previously used for other historic anniversaries, celebrations and commemorations.
- (2) Build and light a traditional bonfire beacon.
- (3) Purchase the gas-fuelled beacon being specially produced for this project. Afterwards, it can be stored and used for future events. See page 10.
- (4) Build and erect a new beacon brazier on a tall wooden pole, using it as a permanent tribute to those that lost their lives in your local community during World War I. See page 11. (You may need to apply for planning permission so please contact your Local Authority Planning Department to seek their advice).

Councils, organisations and individuals taking part will be able to immediately download the official Battle's Over logo free of charge by going to [www.brunopeek.co.uk](http://www.brunopeek.co.uk) and similar for the special certificate shown on page 2 from 30th November 2018 by going to the same website as a permanent reminder of their involvement in this tribute.

Those wishing to participate in the lighting of the World War 1 Beacons of Light, please go to page 9.

As you will see from pages 15, 17, 19, and 21, we have four worthy and appropriate charities associated with this event, representing the Royal Navy, Army, Royal Air Force, and Merchant Navy. Please feel free to make donations direct to one or more of them. You may also wish to consider staging a public collection for them around the lighting of your beacon.

### 7.05pm Battle's Over - Ringing out for peace!

As beacons blaze around the country, bells in 1,000 churches and cathedrals will ring out in celebration of the end of the First World War. Many people in Britain live within hearing of church bells, which call congregations to prayer and mark special occasions. But the sound of mighty bells, some of which are hundreds of years old, also provides a stirring soundtrack to historic events.

The ringing of bells to celebrate the end of the Great War is being organised in association with the Central Council of Church Bell Ringers, the representative body for groups who ring bells in the English tradition with rope and wheel. It was founded in 1891 and represents 65 affiliated societies of local ringers from all over the British Isles and many other countries from Australasia to North America to Africa.

The stirring sound of church and cathedral bells will provide a fitting conclusion to a day of contemplation, commemoration and, ultimately, celebration as our country and other nations reflect on events a century ago on the battlefields of Europe and at home in our factories and farms.

Please encourage your local Cathedral, Minster or Church to participate by ringing their bells at 7.05pm that evening, asking them to provide us with the following information to:

[brunopeek@mac.com](mailto:brunopeek@mac.com)  
**Name of Cathedral, Minster, or Church, Address, Country, County, Name of Contact, Tel, Email**

### Please join us

Those millions of brave men, along with the many left at home, did their duty for their country during the dark days of war, so let us do our duty by them, remembering and honouring them through Battle's Over.

We encourage you therefore to join the many thousands of people already taking part, by participating in this unique community project, commemorating the bravery and personal sacrifice made by so many, along with celebrating the light that emerged from the darkness of war

**Please see acknowledgements from page 23 onwards. These will be updated every three months up to 31st October 2018.**



Photo: Archant Norfolk



*Bruno Peek*

Bruno Peek LVO OBE OPR  
Pageantmaster  
Battle's Over - A Nation's Tribute



# 'Sleep in peace, now the battle's over'

**"The origins of military music derive from the demands of war itself," wrote Lt. Col. David J. Murray in his seminal publication from 1994, *Music of the Scottish Regiments*. "From earliest times until the invention of radio as a means of communication, it had three principal functions. These were to pass orders and give signals in battle; to regulate the military day in camp and garrison; and 'to excite cheerfulness and alacrity in the soldier'."**

The highland piper had been a prominent member of the social hierarchy of Scotland's clan system since the 15th century, when the piper seems to have ousted the bard and the harper from their positions. When the clan took the field as a fighting unit, the piper went with it, and was able, by means of the robust tone and volume of his instrument, both to entertain the men on the march to the battlefield and in their bivouacs, and also, importantly, to encourage them during the prelude to battle by playing the warlike music of the clan. In Gaelic, this rousing is called the 'bronsnachadh.'

The existence of pipes with a Scottish regiment dates to at least the 1680s. At the Battle of Waterloo the pipers played inside the squares as the French advanced, while on the march they played to cheer the soldiers up. All this changed with the arrival of the metalled road, which was to lead to the emergence of the bagpipe and drum combination, and to an avalanche of compositions in march tempo.

From the time of Waterloo, continuous efforts had been made to have the pipers recognised as an integral part of the musical resources of the Scottish regiments. The highland regiments owed the approval of their pipers to the indirect influence of Queen Victoria and it was she who decreed that "the pipers shall play in front" of the regiments. The Queen decided she must have her own piper and in 1843 Angus MacKay was appointed as the first Sovereign's Piper, a tradition that has been maintained by the monarch ever since.

Throughout history there are many examples of military pipers raising the morale of fighting troops at critical moments in battle. Piper George Findlater on the north-west frontier of Afghanistan in 1897, and Piper Daniel Laidlaw VC at the Battle of Loos in 1915 spring immediately to mind. The sound of the pipes boosted morale amongst the troops and intimidated the enemy but in doing so pipers were an easy target for the enemy, particularly during the Great War when they would lead the men 'over the top' of the trenches and into battle. Around 2,000 pipers were either killed or injured.



The origin of the Retreat march was to warn the soldier to return to his company in order to answer to his name at roll call. The tune, *When the Battle's Over* is a classic Retreat march. It was composed by Pipe Major William Robb (1863-1909) of the Argyll and Sutherland Highlanders and established itself quickly in the pipers' repertoire between the Boer War and Great War. It remains a very popular tune with pipers and pipe bands and it is fitting that it is the tune pipers will play at 06.00 hours throughout the United Kingdom and other countries throughout the world as part of the Battle's Over unique tribute that day.

In 1961, the singer Andy Stewart put lyrics to the tune. The chorus goes:

*March no more my soldier laddie,  
There is peace where there once was war.  
Sleep in peace my soldier laddie,  
Sleep in peace, now the battle's over.*



*Stuart Letford*

Stuart Letford,  
Manager, the College of Piping,  
Glasgow, Scotland.



# History of the Last Post - 'The People's Anthem'

**"The Last Post" - A phrase that conjures up sombre thoughts, images, and a sense of finality and closure.**

Although now recognised as the Bugle Call signifying the 'Final Farewell' at a military funeral or Remembrance Parade, it was originally a call used daily by the Army. It followed "The First Post" (which signalled the start of the Duty Officer's inspection of the sentry posts) and signalled that the inspection of the final sentry post had taken place and all was secure for the night. It was first published in 1790, and during any prolonged battle it was also sounded to signal that fighting was over for the day and that any combatants

who were still out in the field or were injured should find help or refuge by following the sound. From 1850 it became the custom overseas for it to be played when a soldier died or was killed in action and for the Regimental Bugler to play it at the graveside. The transition of the Call from being an official tune for timekeeping to one of mourning occurred during the 1880s when the overseas graveside tradition began to be observed at home.

Its use in a symbolic way during Remembrance Day parades and ceremonies signifies its acceptance as a token of remembrance as well as of death.

HG Wells is credited with calling the First World War (or the Great War as it was originally known) "the People's War" and the Last Post became the British People's Anthem, being heard with monotonous regularity during the War. The Last Post was not performed on the first Armistice Day in 1919, but was heard the following year and the practice has continued to this day.

Because of the intensity of this simple piece of music it has been incorporated into the Finale of "In Memoriam" by Robert Steadman as well as "The Armed Man" by Karl Jenkins.

In 1928, the custom started for the Call to be played at the Menin Gate, Ypres, Belgium every night at 8pm, apart from 20th May 1940 to 6th September 1944 due to the German occupation.



Flight Sergeant Isobel Hughes, 1211 (Swadlincote) Squadron, South East Midlands Wing



Flight Sergeant Geraint Jones, 1084 (Market Harborough) Squadron, South East Midlands Wing

Wing Commander G A Singleton  
MCGI FRSA RAFVR(T)  
Principal Director of Music

ROYAL  
AIR FORCE  
AIR CADETS  
the next generation



# Battle's Over - ringing out for peace

## The History of 'English Change Ringing'

**The sound of bells ringing is deeply rooted in British culture. Bells provide the grand soundtrack to our historic moments, calling us to wake, to pray, to work, to arms, to feast, to celebrate and, in times of crisis, to come together.**

The early missionaries used small handbells to call people to worship, with bells being introduced into Christian churches around 400 AD.

Following the Reformation, many churches began to use a new technology of bells mounted on a whole wheel, which gave greater control, with the final refinement of a 'stay' and 'slider' to be able to 'set' the bell. The ringer could now rotate the bells 360 degrees and stop and start the ringing at will.

Competition developed for who had the most bells, and there was increased interest from lay people, who took over the belfry from the clergy. Rules evolved and 'changes' could be learned by heart to create patterns where the bells are never sounded in the same order twice. These compositions were named 'methods', often titled after the cities they were first rung in such as Norwich, London and Cambridge.

By the middle of the 18th century the ability to stand for three hours to ring a peal of 5040 changes was common, with a crowd of listeners eager to hear. Today bells ring out in the English style across the world.

During the First World War c1400 bell ringers lost their lives in service of their country. The Great War Memorial Book of Church Bell-Ringers who fell in the war is on display near the ringing chamber at St Paul's Cathedral, London. It bears the following inscription:

"They whom this book commemorates were numbered among those, who, at the call of King and Country, left all



that was dear to them, endured hardness, faced danger, and finally passed out of the sight of men by the path of duty and self-sacrifice, giving up their own lives that others might live in freedom."

At the end of the war the bells rang out across the country to celebrate the coming of peace, and have followed in that celebratory role ever since. 95% of bells in the UK 'rang in' the Millennium, a bell announced the opening of the London Olympics in 2012 and, as part of the Her Majesty the Queen's Diamond Jubilee celebrations, a floating belfry with eight bells led the Thames Pageant of 1,000 boats.

In 2017 a ring of 8 bells is being installed at St George's Memorial Chapel in Ypres, whose bell tower has stood empty due to lack of funds since the chapel was built in 1927. The project has cost £250,000 in total, but there has been no trouble raising those funds - the fallen of the Great War are not easily forgotten, and the sound of bells ringing out both in commemoration and to celebrate peace is clearly still as important to many as it was in 1918.

Christopher O'Mahony,  
President of the Central  
Council of Church Bell  
Ringers.



# How to take part & Beacon Lighting Ceremony

## How to take part

**Step 1:** To confirm your involvement and assist us in easy communication and correct registration of your event, please be kind enough to undertake the following in FULL as soon as possible, sending it to Bruno Peek LVO OBE OPR, Pageantmaster, Battle's Over - A Nation's Tribute & WW1 Beacons of Light at - [brunopeek@mac.com](mailto:brunopeek@mac.com)

If your event is a private occasion and NOT open to the public, and you do not want your involvement shown on any public or media listing, it is important that you confirm this when providing information requested below. Your participation will still be noted as part of this historic occasion but NOT made public.

However, if your event is open to the public your contact details will be shared with the media so that they can contact you direct to arrange any publicity and/or coverage of your event on 11th November 2018.

Name of Contact/Coordinator  
Name of Council or Organisation  
Job title of Coordinator  
Full postal address including postcode  
County  
Country: England, Wales, Scotland, Northern Ireland, Channel Islands, Isle of Man, UK Overseas Territory  
Telephone number - landline  
Mobile number  
Email Address  
Beacon Location if known when registering, including postcode

Please ensure you have undertaken all the safety aspects etc, outlined on page 6 and before the lighting of your Bonfire Beacon on page 5 and you have alerted the emergency services, including the Fire Brigade, undertaken any risk assessments required and ensure all are happy with your plans. (This is your responsibility as coordinator of your Beacon lighting event).

## Beacon Lighting Ceremony - 7pm on 11th November 2018

The Beacon lighting ceremony should be undertaken as follows:

**Step 2:** Invite your Lord Lieutenant, DL, Lord Mayor, Mayor, High Sheriff, High Steward, Lord Provost, Chairman or Leader of the Council. However, you may wish to consider running a competition in partnership with your local media, with the winner having the honour of lighting your WWI Beacon of Light at 7pm that evening.

**Step 3:** Please arrange to have professional photographs taken during your event, and immediately after, please send NO more than TWO high quality, copyright-free photographs to [brunopeek@mac.com](mailto:brunopeek@mac.com) including the name of the photographer, the Beacon location, including postcode, along with the name of the Council or Organisation.

**Step 4:** If appropriate, please use social media channels - Twitter, Facebook etc - to promote your event. On Facebook, post photographs of your Beacon lighting ceremony on the 11th November 2018.

**Step 5:** On 1st November 2018 we will be providing you with an outline Press Release for your use, so please localise it, providing as much or as little information as you wish regarding your event, along with your contact details before YOU send it to all areas of your local media to enable them to contact YOU direct.

**Step 6:** Before the lighting of your Beacon at 7pm you may wish to consider reading out the names of those from your City, Town or Parish etc killed in action, during WWI, in remembrance of the sacrifices made.



Bonfire Beacon, Killyleagh, County Down, Northern Ireland.



Beacon at Manor Farm, Strete, Devon, courtesy of Kate Gill, Stete Parish Council.



# WWI Beacons of Light, your unique gas-fuelled Beacon

**The Battle's Over Beacon is of lightweight construction and comes assembled and complete with the exception of the gas cylinders that will need to be purchased separately:**

a) 400g disposable cylinder of propane, (Bullfinch No 1644, or equivalent) for the FirePower Torch used to light the Beacon. These can be purchased from many DIY stores or Builders Merchants.

b) One full 47 kg propane cylinder or 2 x 19 kg full cylinders are recommended to give a full flame for an hour. For longer periods of burning or with partially full cylinders you will need double the number of cylinders. These cylinders can be purchased from Flogas Britain Ltd by calling 0800 085 6225 quoting Gas Fuelled Beacons or by going to their website [www.flogas.co.uk](http://www.flogas.co.uk) where you can either order your cylinder online or locate your nearest Flogas stockist. You may also



download a propane cylinder safety data sheet from the Flogas website ([www.flogas.co.uk/safety](http://www.flogas.co.uk/safety)).

The Gas-Fuelled Beacon package will contain the following:

- Burner unit with distinct design to commemorate the event - with the motif WWI 1914 18 round the circumference
- 2m high stand with an anchor for fixing to the ground
- 10m hose with the regulator for connecting to the gas cylinders
- FirePower Gas torch for lighting the burner (you will need a 400g disposable cylinder of propane for this - (see above))
- Spanner
- Leak detecting fluid
- Hose assembly and Y manifold to link 2 cylinders
- Lighting and safety instructions

The above items are packed into 2 strong cartons.

The tripod describes a circle area of about 1.32m diameter and the beacon has an extended height of about 2.15m.



The Beacon (and flame) are stable in the wind up to 30 mph. It is supplied with a ground anchor and rope for securing to the ground if this is possible, or else we would recommend the use of sand bags. Full instructions are provided for this. The Beacon must be supervised by 2 people at all times when lit and a fire extinguisher must be provided. It is important that the supervision should be undertaken by those who are competent and it is essential that a trial be undertaken before the event to ensure that everyone is fully trained and familiar with the operation.

See our website [bullfinch-gas.co.uk](http://bullfinch-gas.co.uk) for more details.

The price is £360 plus VAT including carriage within the UK Mainland. There will be an extra carriage charge for other areas.

To order please contact:

Bullfinch Gas Equipment, Kings Road, Tyseley, Birmingham, B11 2AJ.



Tel: 0121 765 2000

Fax: 0121 707 0995

Email: [sales@bullfinch-gas.co.uk](mailto:sales@bullfinch-gas.co.uk)

Web: [www.bullfinch-gas.co.uk](http://www.bullfinch-gas.co.uk)

Payment by Bank Transfer, Credit/Debit Card or Cheque. Payment will not be asked for until the Beacon is about to be despatched. Last date to order to guarantee delivery by 1st November is 31st August 2018. However please enquire after this date for availability.



Gas fuelled Beacon, Berkley Castle, Gloucestershire, England.





# WWI Beacons of Light, Beacon Brazier

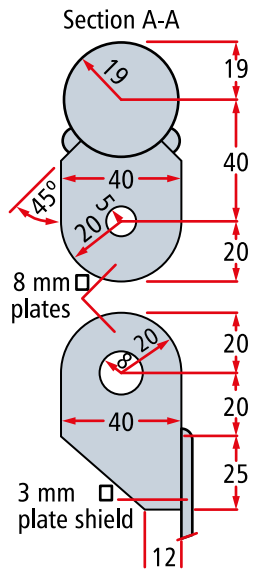
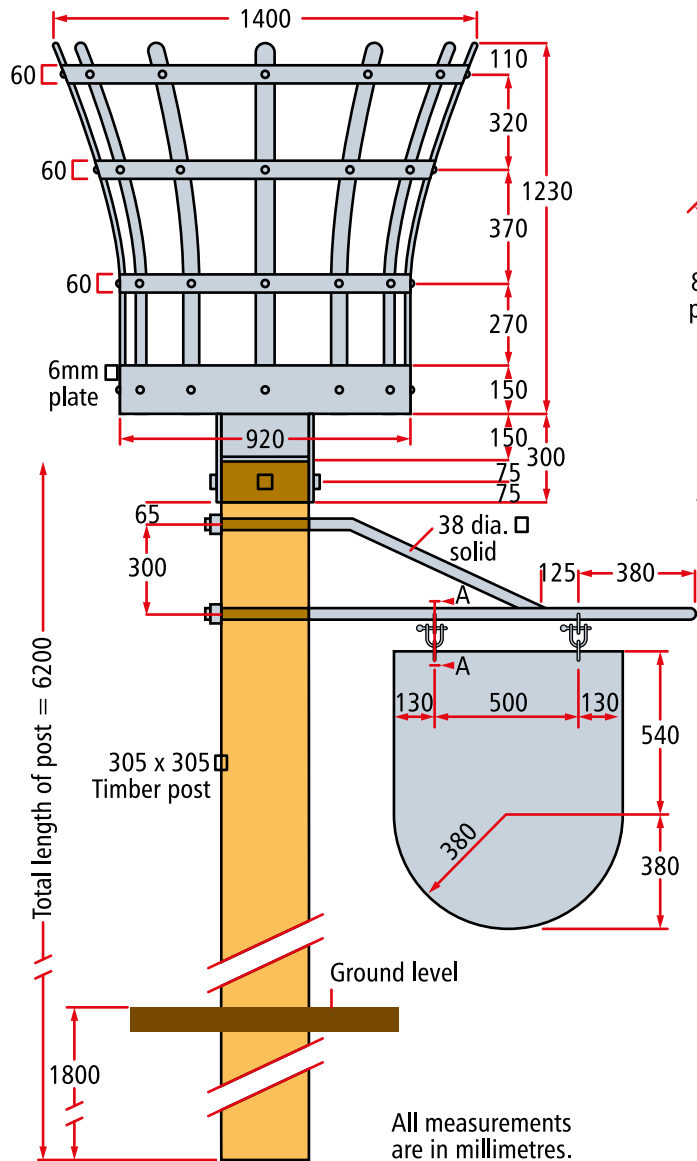

## Beacon Brazier with Metal Shield

A Beacon Brazier can be a more permanent fixture, sited in a country park, hilltop or village green, as a lasting memorial of this important moment in history commemorated, and could be manufactured and erected by using local craftsmen.



## Materials Required for Beacon Construction

Wooden centre post consisting of 305mm x 305mm wooden post, 6.25 metres in length of which 2 metres goes into the ground.

Basket and fixing brackets consisting of:

- 1 x 920mm diameter steel plate.
- 1 x 4,178 long 60mm x 5mm steel flat bar rolled into 1,330mm diameter ring.
- 1 x 3,455mm long 60mm x 5mm steel flat bar rolled into 1,100mm diameter ring.
- 1 x 2,985mm long 60mm x 5mm steel flat bar rolled into 950mm diameter ring.
- 1 x 2,922mm long 150mm x 5mm steel flat bar rolled into 930mm diameter ring.
- 12 x (approx 1,250mm long) 60mm x 5mm vertical bars (rolled to shape).
- 1 x 310mm x 310mm x 300mm high connection box welded to base of basket.
- 1 x hanging shield and support: 3.7m length of 38mm diameter solid steel rod.
- 1 x 920mm x 760mm steel plate 3mm thick 4 x connection brackets 8mm thick (see detailed drawings left).
- 2 x pins and loops.



# WWI Beacons of Light Bonfire Beacon

Locate the bonfire at least 30m away from buildings, roads, railways and public rights of way, and a safe distance from dangerous materials and overhead power lines. Ensure it has good access for the transportation of materials for the bonfire and sufficient space for spectators to stand upwind.

Obtain the landowner's permission and involvement.

Liaise with local fire brigade and emergency services, presenting them with your plans, and seek their advice and support.

**1** Prepare site by removing top layer of turf and stack away from fire area. Obtain seven poles, 5-6m in length. Attach four guy ropes to top of one pole and anchor as shown.

**2** Erect remaining poles as shown, ensuring tops are secured in place.

**3** Use either pallets or suitable lengths of timber, spreading them over ground area of beacon for a good through draught. Secure timber horizontally between poles as shown, preventing material placed over the framework from dropping through. Construct access

tunnel to the middle of the beacon. Keep middle empty until required. Always construct the bonfire so it collapses inwards as it burns.

**4** Use only wood for combustible materials. Do not burn dangerous items such as foam-filled furniture, old tyres, aerosols or tins of paint. Build upwards until height of centre pole is reached. Materials around top should be loosely packed to allow air flow. Cover bonfire to keep it dry.

**5** Fill centre with suitable, dry combustible materials. Check construction is stable and remove any unsuitable materials that may have been added. Look specifically for fireworks, aerosols, highly inflammable materials or containers with such materials.

**6** Construct a safety barrier out of ropes and stakes or scaffold poles to ensure public is kept at a safe distance from the fire.

**7** In daylight, and just before lighting, check that there are no children or animals playing or hiding in the bonfire. Arrange for, and brief sufficient numbers of marshals.

**8** The person looking after the fire should not wear lightweight clothing that could ignite easily. They should wear a substantial outer garment of wool, or other material of

low flammability, and stout boots. They should know what to do in the event of a burn injury, or a person's clothing catching fire, and should have a fire blanket ready in the bonfire area along with a number of fire extinguishers.

**9** Lighting: the safest and recommended approach is to use paper and solid firelighters in six places just inside the walls of the beacon to ensure an even burn. Never use flammable liquids such as paraffin or petrol to get it going as this can result in uncontrolled spread of fire or explosion.

**10** To light the beacon: from poles 2m in length, prepare hand torches for lighting with paraffin-soaked rags wired around one end. Remember, paraffin is dangerous and great care should be taken. Paraffin can be used as directed, but it is still dangerous and should at all times be treated with great care - for example, always ensure all excess paraffin is drained off rags before use. If spilt on your clothes during the preparation of your beacon lighting you should replace those items of clothing before approaching any naked flames. In particular, always remember to replace the lid on any container of unused paraffin and store it in a safe place away from naked flames. Do not use an accelerant on the fire itself.



Bonfire Beacon, Shipston-on-Stour, Warwickshire, England.

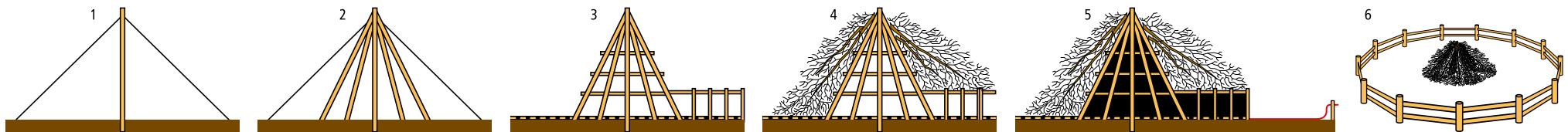

▲ After the event, extinguish fire and collect remaining debris. ▲ Dig over site and re-lay turf. ▲ Leave site clean and tidy.



# Your responsibility, Legal Essentials and Safety

If you are inviting personal guests to your home it is worth checking with your household insurer that you are covered in the unfortunate circumstances that there should be an accident. If your event includes inviting the public, or it is a third party venue then, where applicable, the following advice should be heeded, to ensure you have a safe and enjoyable event for everyone involved.

## Licensing

Your local authority is responsible for licensing of such events. This includes the sale of alcohol (please see separate section) and Regulated entertainment, which includes live and recorded music along with other types of entertainment. Generally if there are going to be no more than 499 people present at your event, including staff and performers you can apply for as Temporary Event Notice. This is a simple process and can be obtained from your local Council and completed on line for only £21. If you expect more than the 499 people you will require a Premises licence to allow your event to take place. This process takes at least 28 days after you have submitted your forms, so leave plenty of time, the process may seem complicated but you can get assistance from your local licensing service at the Council. Local authorities will treat each event individually. The licensing officer's job is to advise the local authority's licensing committee on the granting of a licence should anyone object. If there are no objections the licence will be granted but you may have to agree to some conditions. It is always worth checking before you apply with the Councils licensing service to see if location already has a licence, as some open spaces are already licensed. Talk to the licensing officer as soon as possible. In Northern Ireland, if you plan to sell alcohol at an event, you will need to apply for an occasional liquor license from the Northern Ireland Court Service.

## Safety Advisory Groups

A lot of local authorities run Safety Advisory Groups for events, these groups consist of all emergency services plus other members such as the Highways authority. They can provide you with all the information you require and some have example event plans to assist you organising your events, you can normally contact them through your local Council or the Police events officers.

## Insurance

Unfortunately accidents can happen at even the best organised events. Therefore you will need to consider and obtain insurance cover for your event, whether you are holding an event on your own premises or someone else's. Beacon/Bonfire events require specialist public liability cover. If you hire a park or venue or use land owned by a third party for your activity, they are likely to require you to have your own suitable insurance to cover your liability for any injury to the public or damage to other people's land or property. If hiring equipment for the event, you may need to insure these items; you may also need to consider cover for loss of any financial outlay you incur if the event has to be cancelled for reasons beyond your control, or loss of money, particularly if you are holding a fund-raising event. To help you obtain the appropriate insurance, and risk management advice, we are working closely with Unity Insurance Services, which is a specialist insurance broker in the voluntary and non-profit sector. They have developed a range of bespoke insurance covers specifically for the Beacon/Bonfire events. Unity is owned by a charity, The Scout Association, and donates all its profits back to charity. To obtain a quote or for more details or advice on the insurance cover you may need, please visit Unity's website, [www.unityinsuranceservices.co.uk/beacons](http://www.unityinsuranceservices.co.uk/beacons) or telephone them on 0345 040 7702.



Alternatively, the licensing officer may be able to direct you to a suitable specialist company or broker, but you should not try to source this kind of insurance from a non-specialist.



## Emergency Services

Tell the police well in advance about the type of event you are planning, and get in touch with your local community police officer. Write to the fire brigade and ambulance service, particularly if you are planning to have a Beacon/Bonfire, fireworks, or an event that will attract a large crowd. St John's Ambulance and the British Red Cross will provide first aid and sometimes a vehicle. You can be expected to be charged for these services. If your Council has a Safety Advisory group this process will be part of the process and will save time.



## Food and Drink

Basic food hygiene guidelines should be followed at all times if you are providing food and drink. Caterers must have food hygiene certificates. Advice on this subject can be obtained from your local council environmental officer. If you are using outside catering companies check with your local authority to see if they are a registered food business.



## Alcohol

If you wish to sell alcohol at your event you will need to obtain a licence, please see the section above on licensing, it is important that you obtain the correct permissions and your local authority Licensing service will help you do this. You can normally use a temporary events notice for a bar as only a small number of people can be present (less than the 499 limit).



## Site Clearance

The local authority will arrange for clearance and disposal of litter after your event if it is on public ground (check for possible charges). You can help this process by arranging litter bins or recycling bins around the site, and a crew to clear up throughout the event.



## Hiring or Borrowing Equipment

Your local authorities, or local event organisers may be able to help you with contacts for supplies such as marquees, portable toilets, barriers and bunting, or may in some cases have these for you to hire and borrow. You may also need to consider generators, a public address system, and emergency flood lighting. If you need to arrange insurance for your hired equipment, Unity Insurance Services can arrange this for you too. If you hire a Marquee make sure the company providing it provide you with the necessary safety certificates.



## All Ability Access

Access for the disabled is very important. Many local authorities run community transport schemes. Talk to them about arranging transport. On green field sites access may be improved by cutting the grass before the event.



# *Message from the First Sea Lord Admiral Sir Philip Jones KCB ADC Chief of Naval Staff*



Admiral Sir Philip Jones KCB ADC  
First Sea Lord and Chief of Naval Staff

Images of trenches and barbed wire are an indelible part of our collective national memory, but the First World War also reached far beyond the Western Front. At sea, it stretched from the Battle of Jutland in the North Sea to the twin battles of Coronel and the Falklands in the South East Pacific and the South Atlantic Oceans, while to the east it spilled onto the beaches and clifftops of the Gallipoli Peninsula in Turkey. The lighting of Beacons will be an opportunity for families and communities around the country and overseas to remember their individual connections to these global events, and the many personal examples of courage and sacrifice.

As these Centenary commemorations draw to a close, the memory of those who fought in the First World War must never be extinguished. We must continue to learn the hard won lessons of this terrible war, because today, as was the case a century ago, our own national wellbeing is indivisible from the cause of peace and security in the wider world.



# The Royal Naval Association is proud to be associated with 'Battle's Over - A Nation's Tribute'

**With over 16,000 members across 300+ branches in the UK and overseas, we are a family of current and former Naval Service personnel, relatives and supporters of our country's Royal Navy.**

Whether we are catching up with friends at our regular social events; fundraising; advising on welfare and employment matters, or just providing an arm around the shoulder, our natural willingness to help others stems from the tradition and camaraderie that only Naval Service life can instil. Everything we do is inextricably linked to our core values:

## Unity

Shared backgrounds and equality in rank. We share the same bonds, the same mindset, and even the same language (Jackspeak!). We are all equal. We are the heart and soul of the RNA.

## Loyalty

To each other and our dependants. We will always support and look out for each other. Our loyalty is to all our shipmates, our local communities, the personnel and dependants of the Naval Service, along with other charities or organisations with naval connections.

## Patriotism

We are proud to serve and proud to represent our country and the Naval Service. Our pride in serving our country never leaves us. Nor do we forget those who have fallen for our country or who fight now. We are deeply honoured to represent them on both a national and international level.

## Comradeship

Friends in fun, fellowship and need. Your shipmates will always be here for you, whether it's about a job, ideas for a fun day out or just an arm around the shoulder. We will never leave you or your dependants in despair.

The Royal Naval Association has lots of great things going on:

- Project Semaphore to bring digitally isolated naval veterans online.
- Befriending naval veterans who need an arm around the shoulder.
- 3 minibuses fitted with wheelchair hoist for socially isolated veterans.
- Support for those leaving the Royal Navy - the Shipmates and Oppos programme.
- We support and lead the Conference of Naval Associations, a group of 70 like-minded naval associations, bringing great benefits and working together. [www.cona.org.uk/](http://www.cona.org.uk/)
- Most importantly we have fun together with our regular meetings and organised events - such as our annual reunion and Conference and the Remembrance Sunday march at the Cenotaph.

The RNA has been involved with many aspects of commemoration of the First World War.

- Our National Standard led the parade at the National Event at Lyness cemetery on the Orkneys for the Battle of Jutland, our members have been part of many events.
- We have lent the Chapel door of HMS WARSPITE to the National Museum of the Royal Navy - for their Jutland Exhibition running in Portsmouth from 2016 to 2020.
- We are the lead sponsor with the Woodland Trust in the establishment of the Jutland Wood as part of their WW1 Centenary Wood Project. The wood will consist of 6,094 trees - reflecting the number of Royal Navy sailors who lost their lives on that day in May 1916. The RNA has sponsored two of the large specimen trees in the main avenue, and hope to have members at the planning at Langley Vale Epsom in the Winter of 2017.

[www.royal-naval-association.co.uk](http://www.royal-naval-association.co.uk)

RNA Central Office, Room 209, Semaphore Tower,  
HM Naval Base, Portsmouth, PO1 3LT

[admin@royalnavalassoc.com](mailto:admin@royalnavalassoc.com)  
02392723747

You can donate to the RNA at:  
[www.royalnavalassociation.co.uk/about-us/help-us/](http://www.royalnavalassociation.co.uk/about-us/help-us/)



# ROYAL NAVAL ASSOCIATION

# Message from General Sir Nicholas Patrick Carter KCB CBE DSO ADC Gen Chief of the General Staff

**The Beacons of Light Tribute is a poignant reminder of the darkness brought by war so evocatively captured in Sir Edward Grey's quote from 1914.**

*"As the lights go out and the beacons are lit it is timely to reflect on what we might learn from our forefathers' experiences. We owe it to those who have gone before us to help the younger generation, further removed by time from war, to see beyond the mud and the blood and the casualties. We might learn about national resilience and community spirit, and in being prepared to fight the war we might have to fight, there is a much better chance of deterring that war from ever happening."*



*Nick Carter.*

General Sir Nicholas Patrick Carter  
KCB CBE DSO ADC Gen

Chief of the General Staff



**ARMY**



**ABF The Soldiers' Charity is the National Charity of the British Army. Originally established as the Army Benevolent Fund in 1944, we provide a lifetime of support to soldiers, veterans and their immediate families in times of need.**

### How we help

We give financial assistance to individuals as well as make grants to a large number of specialist charities and partner organisations such as Combat Stress, SSAFA and the NSPCC, which provide support on our collective behalf.

The scope of our work is huge; from providing funding for specialist medical equipment for the 6-month old child of a serving soldier, to assisting with the care home fees of a 105-year-old veteran, our work touches the lives of around 80,000 people each year, sustaining the British Army 'family' both at home and around the world. We are The Soldiers' Charity: 'For Soldiers - For Life'.



### How you can help

From abseils, skydives and 24-hour hikes across the Scottish wilderness, to cake sales, big curries and cycling challenges, there are many ways for you to get involved and support our work. However you choose to support us, your contribution will go a long way to making a difference to the lives of serving and veteran Army personnel, and their families.

We don't receive any statutory government funding, so we rely on the generosity of our supporters to ensure we can continue to be here, supporting the men and women of the British Army.

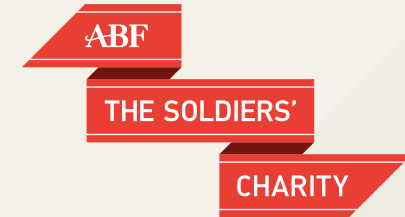

## The Army's National Charity

For more information on The Soldiers' Charity or to make a donation, visit [www.soldierscharity.org](http://www.soldierscharity.org) or email [info@soldierscharity.org](mailto:info@soldierscharity.org)



[facebook.com/soldierscharity](https://facebook.com/soldierscharity)



[@soldierscharity](https://twitter.com/soldierscharity)



[instagram.com/soldierscharity](https://instagram.com/soldierscharity)

ABF The Soldiers' Charity is a registered charity in England and Wales (1146420) and Scotland (039189). Registered as a company limited by guarantee in England and Wales (07974609).

Registered Office: Mountbarrow House,  
12 Elizabeth Street, London SW1W 9RB

*Message from the Air Chief Marshal Sir Stephen Hillier*  
*KCB CBE DFC ADC MA RAF*  
*Chief of the Air Staff*



**This Tribute will be supported across the length of the UK and the breadth of her overseas territories.**

All of these communities made significant sacrifices in the seas, fields and skies during World War I, and this act provides the perfect opportunity to commemorate those hardships. And yet, the return of these beacons of light to the darkness reminds us of the hope which carried the Nation and her citizens through. That message of hope and inspiration is particularly apt in the centenary year of the birth of the RAF as the world's first independent air force, and I welcome the opportunity to reflect on both the grave losses and the incredible achievements which occurred during those dark years.

Air Chief Marshal  
Sir Stephen Hillier  
KCB CBE DFC ADC MA RAF

Chief of the Air Staff





# THE HEART OF THE RAF FAMILY SINCE 1919



**Royal Air Force  
Benevolent Fund**  
THE HEART OF THE RAF FAMILY



Since our foundation in 1919, the RAF Benevolent Fund has been there, through thick and thin, supporting the RAF family.

Our principal activities are to provide assistance to the RAF family when they are in need, maintain and preserve the RAF Memorial in London on behalf of the nation, support the morale and wellbeing of the serving RAF and be responsible for the Bomber Command Memorial in central London.

## HOW WE HELP

We routinely help over 41,000 individuals every year, by providing a range of support aimed at serving and former RAF personnel. We also support members of the Air Cadet Organisation, including members of the Combined Cadet Force RAF component, if they are injured whilst on duty.

They include welfare breaks for families and veterans, grants to help with getting about inside and outside the home, specialist advice on benefits and care services, individual grants for RAF Stations and Station personnel and support for young people through our Airplay programme.

By working with others, we ensure that members of the RAF family get the right support, when it's needed. Last year we gave over £1m in external grants to over 50 charities and organisations including RAFA, SSAFA and the Royal British Legion.

## HOW YOU CAN HELP

There are lots of ways you can get involved with the RAF Benevolent Fund and we always welcome your support.

And don't forget whatever you do, no matter how small, will go a long way in helping us make a difference to the lives of RAF personnel, past and present, and their families. From cake sales to fun runs, cycling challenges to dinners, your support matters.

We receive no regular government funding, so we rely entirely on people like you to continue our work supporting the men, women and children of the RAF family whenever they are in need.

For more information on the RAF Benevolent Fund or to make a donation, visit [www.rafbf.org](http://www.rafbf.org), or email [info@rafbf.org.uk](mailto:info@rafbf.org.uk).



# Message from Captain John Sail - National Chairman, The Merchant Navy Association



**'Battle's Over' offers a wonderful opportunity to both record and remember what was endured and forgiven but not forgotten.**

During the First World War attacks on merchant ships began slowly as the enemy sought to blockade Great Britain. In 1914 and 1915 a total of 342 ships and nearly 2,500 men, women and boys lost their lives with more being injured. During 1916 alone 396 ships and 1,217 seafarers lost their lives and if it were not for the introduction of the Convoy System, in 1917, many more merchant ships and their crews would have been lost and very likely the war as well. The Battle of the Atlantic was one of the most significant battles of that war and for the seafaring communities across the UK and overseas. We will remember them all now their 'Battle is Over'.

*John Sail*

Capt J M R Sail MNM MNI  
MNA National Chairman

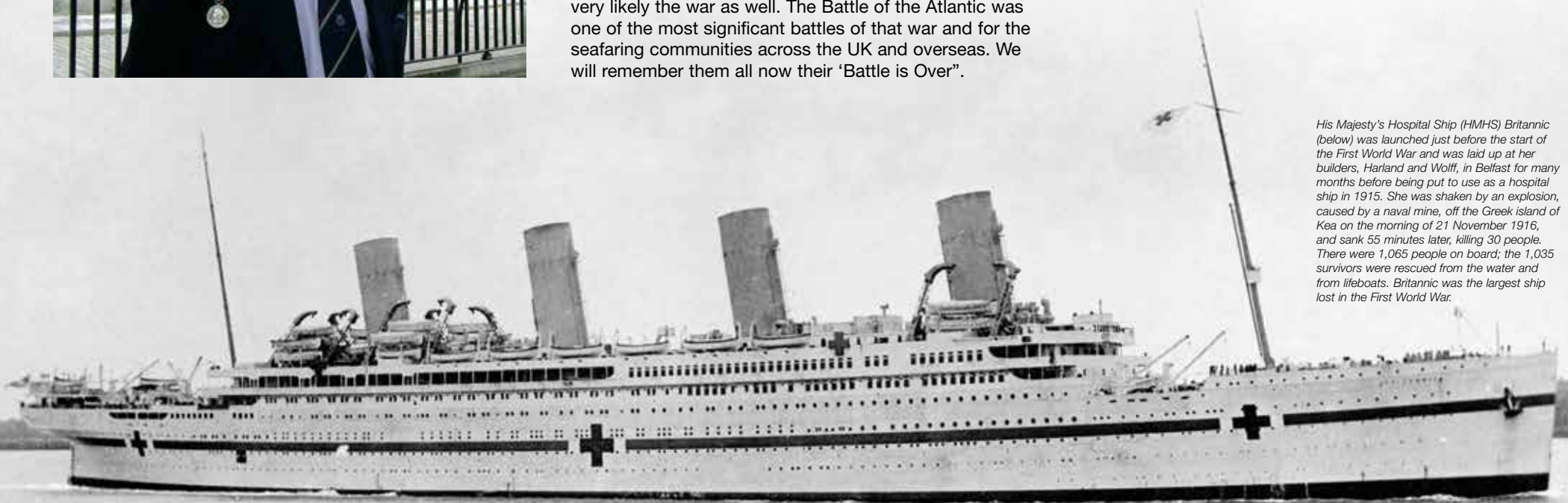

*His Majesty's Hospital Ship (HMHS) Britannic (below) was launched just before the start of the First World War and was laid up at her builders, Harland and Wolff, in Belfast for many months before being put to use as a hospital ship in 1915. She was shaken by an explosion, caused by a naval mine, off the Greek island of Kea on the morning of 21 November 1916, and sank 55 minutes later, killing 30 people. There were 1,065 people on board; the 1,035 survivors were rescued from the water and from lifeboats. Britannic was the largest ship lost in the First World War.*





# The Merchant Navy Association

from ship to shore, from past to present

The merchantile marine, as it was termed in those times, played a significant and often critical role throughout the First World War...much the same as it would two decades later. In both world wars merchant seafarers and fishermen fought the enemy, the weather and the seas to keep the nation and the Armed Services supplied and able to defend themselves. Their way of life and conditions of service were austere with seafarers often not returning home for over two years, some having been sunk, survived and transferred to other ships to maintain those lines of support.

During the First World War attacks on merchant and fishing vessels began quite slowly but increased significantly as the enemy sought to blockade Great Britain. In 1914 and 1915 a total of 342 merchant vessels were lost to enemy action with 2,471 men, women and boys losing their lives. During 1916 there were 396 ships and 1,217 seamen killed. In the following year, 1917, the losses were so severe that the ships being built could not match the number of ships being lost in action with six ships a day being sunk on some days. The loss of life was increasing significantly. It was so severe that if the rate of losses of ships and men had continued the war would have been lost. No food, no fuel, no wood, no arms and ammunition especially some of the 91 million shells that were eventually produced and transferred by sea. In that year 1,197 ships were sunk through enemy action and 6,408 seamen were lost at sea with their ships...their only grave the sea. The losses had to be decreased and this was achieved by the introduction of the Convoy System in 1917. In 1918 the impact of the actions in the previous year were clearly evident with 544 ships and 4,122 seamen lost.

The total recorded losses for the First World War were 2,479 ships and 14,287 seamen plus 675 vessels of the fishing fleet and 434 seamen. There were many more seafarers who died ashore and were not commemorated. They had to die at sea to be commemorated even when they were hospitalised because of their wounds. They were also off pay when their ships were sunk. They actually had to die at sea to be commemorated.

The men, women and boys who were lost at sea during the First World War included lads such as Redan Sydney Jeffries (aged 13) of Lowestoft, presumed drowned on 24th October 1917. Redan was a Cook aboard the fishing vessel Vanguard. More than twenty-nine Boy seamen aged only 14 lost their lives for their King and Country. At the other end of the scale were men long overdue for retirement who insisted on "doing their bit" and who paid the ultimate sacrifice. Men such as A.B. Patrick Casey, aged 73, killed when the S.S. Dotterel was sunk by a mine off the French coast on 29th November 1915....they were the forgotten heroes, their lines of support were never broken.

**Capt J M R Sail MNM MNI, MNA National Chairman**

**Please donate what you can, when you can,  
as often as you can. Small donations will make a  
big difference.**

**Contact [www.mna.org.uk](http://www.mna.org.uk)  
and access the DONATE button.**

# *Battle's Over - A Nation's Tribute & WWI Beacons of Light*

## *Chosen Charities*

Please give generously to one or more of our four chosen charities for this unique, historic tribute to the many that either died or returned home dreadfully wounded defending our freedom during the four dark years of World War I.



**ROYAL NAVAL  
ASSOCIATION**

Please donate at:  
[www.royal-naval-association.co.uk/about-us/help-us/](http://www.royal-naval-association.co.uk/about-us/help-us/)



**Royal Air Force  
Benevolent Fund**  
THE HEART OF THE RAF FAMILY

Please donate at:  
[www.rafbf.org/ways-to-give](http://www.rafbf.org/ways-to-give)

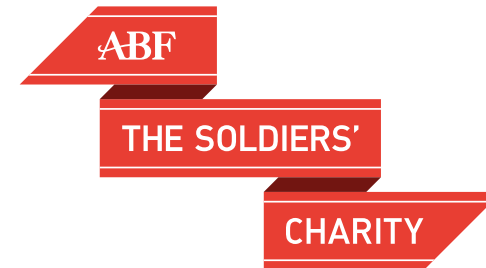

**The Army's National Charity**

Please donate at:  
[www.soldierscharity.org](http://www.soldierscharity.org)



**The Merchant Navy Association**

Please donate at:  
[www.merchantnavyfund.org](http://www.merchantnavyfund.org)



# Battle's Over - A Nation's Tribute & WWI Beacons of Light Acknowledgements

This event is being organised in association with:

The Society of Editors, Army Cadet Force, Air Training Corps, Sea Cadet Corps, Combined Cadet Force, Association of English Cathedrals, Merchant Navy Association, Royal Naval Association, ABF The Soldiers' Charity, Royal Air Force Benevolent Fund, The Buglers Association of The Light Division & Rifles, Trinity House, National Association of Local Councils, National Association of Civic Officers, One Voice Wales, National Trust, English Heritage, Central Council of Bellringers, The College of Piping and the National Union of Mineworkers (formerly known as Miners Federation of Great Britain).  
For further information relating to the Central Council of Church Bell Ringers, please visit: [www.cccbr.org.uk](http://www.cccbr.org.uk)

We would like to thank the many and various councils, churches, organisations, local communities, commercial companies, private land owners and others to date listed below, for their generous participation in this unique, local community tribute.

*There are a number of others taking part as private occasions, so are not open to the general public so have asked not to be listed.*

**(The Merchant Navy Association will be lighting 12 further Beacons, the locations of which will be confirmed nearer the date).**

## ENGLAND

### BEDFORDSHIRE

Leighton-Linslade Town Council  
Silsoe Parish Council  
Potton Town Council  
Luton Borough Council  
Billington Parish Council  
Stanbridge Parish Council  
Shefford Town Council  
Millbrook Parish Meeting  
Amphill Town Council, Amphill Armistice 100 Committee including The Royal British Legion, Army & Navy Cadets  
Sandy Town Council  
Stotfold Town Council

### BERKSHIRE

Wraysbury Parish Council  
Newbury Town Council  
Slough Borough Council  
Datchet Parish Council  
Englefield Estate  
Royal Borough of Windsor and Maidenhead & Crown Estate  
Hungerford Town Council  
Sunningdale Parish Council

Donnington Castle - (English Heritage)  
Thatcham Town Council  
Eton Town Council  
Finchampstead Parish Council & St James's Church, Finchampstead

### BUCKINGHAMSHIRE

The Parks Trust - Milton Keynes  
Olney Town Council  
Akeley Parish Council  
Wolverton & Greenleys Town Council  
Berryfields Parish Council  
Stoke Poges Parish Council  
Beaconsfield Town Council  
Great Horwood Parish Council  
Little Horwood Parish Council  
Quainton Parish Council  
Cublington Parish Council  
Steeple Claydon Parish Council  
Whaddon Parish Council

### CAMBRIDGESHIRE

St Neots Town Council  
Huntingdon Town Council  
Chatteris Town Council  
Eltisley Village

Warboys Parish Council  
Cottenham Parish Council  
Sawtry Parish Council  
East Cambridgeshire District & City of Ely Council

### CHESHIRE

Northwich Town Council  
St Oswald's Church - Lower Peover  
Beeston Parish Council & Beeston Castle  
Alsager Town Council  
Tushingham, Macefen & Bradley Parish  
Winsford Town Council  
Frodsham Town Council & Frodsham WWI Commemoration Working Group  
Disley Parish Council  
Little Budworth Parish Council  
Wybunbury Parish Council  
Beeston Castle - (English Heritage)

### CLEVELAND

Billingham Town Council

### CORNWALL

St Michael's Mount (FAR WEST TIP OF ENGLAND)

Torpoint Town Partnership  
Lizard Lighthouse - Trinity House  
Pelynt Parish Council  
St Mabyn Parish Council  
Liskeard Town Council  
St Stephens by Launceston Rural Parish Council  
Penzance Town Council  
Helson Town Council & Helston WWI Heritage Project  
South Petherwin Parish Council  
Madron Parish Council  
Gwennap Parish Council  
Marazion Town Council  
Carn Brea Parish Council  
Probus Parish Council  
St Enoder Parish Council  
Morval Parish Council  
The Ruan Social Group (RSG)  
St Cleer Royal British Legion - & other organisations  
Rotary Club of Bodmin  
Morwenstow Parish  
Launceston Town Council  
North Tamerton Parish Council  
St Michael Penkivel Parish Council



# Acknowledgements

## COUNTY DURHAM

Brandon and Meadowfield Royal British Legion, Carrside Youth and Community Project and St. John's Hall, Meadowfield  
Shotley Bridge Cricket Club  
Ferryhill Town Council  
Hartlepool Borough Council  
Waldridge Parish Council  
St Andrew's Church - Winston  
Brandon & Byshottles Parish Council  
Manfield with Cliffe Parish Council  
Great Aycliffe Town Council  
Barnard Castle Town Council  
Spennymoor Town Council  
Coxhoe Parish Council  
Barnard Castle - (English Heritage)  
Eggleston Parish Council

## CUMBRIA

Brampton Parish Council  
Provincial Grand Lodge of Cumberland and Westmorland Freemasons  
Whitwell and Selside Parish Meeting  
Mansergh Parish Meeting  
Heversham Parish Council  
Matson Ground Estate Co Ltd  
Cumberland & Westmorland Freemasons  
Windermere Lodge 2217  
Windermere Town Council  
Torver Parish Council  
Coniston Parish Council  
Dalston Parish Council  
Milburn Parish Council  
Muncaster Parish Council (3 Beacons)  
West Cumberland Freemasons  
Lamplugh and District Heritage Society & Lamplugh Young Farmers  
Maryport Town Council  
Scaleby Parish Hall Committee  
Bootle Parish Council, Millom Without Parish Council and Whicham Parish Council

Bewcastle Parish Council  
Dearham Parish Council  
Millom Town Council  
Blindbotheil Parish Council  
Carlisle Castle - (English Heritage)  
Birdoswald Roman Fort - (English Heritage)  
Castle Carrock & Geltsdale Parish Council

## DERBYSHIRE

Erewash Borough Council (2 Beacons)  
South Derbyshire District Council  
Shardlow Church and Shardlow & Great Wilne Parish Council  
Duffield Parish Council  
Pilsley Parish Council  
Northwood and Tinkersley Parish Council  
Bradwell Parish Council  
Aston-on-Trent Parish Council  
Horsley Woodhouse Parish Council & Horsley Woodhouse Scout Group  
Whaley Bridge Town Council  
High Peak Borough Council  
Chelmsorton Parish Council  
Derbyshire & Lancashire Gliding Club  
Pevelevil Castle - (English Heritage)  
Dethick, Lea and Holloway Parish Council  
Holymoorside & Walton Parish Council

## DEVON

Blackborough Village  
Bishopsteignton Parish Council  
Delamore Estate  
Lymptone Parish Council  
Exeter City Council  
Kings Nympton Community Group  
Germansweek Parish  
Start Point - Trinity House  
Plympton & District Civic Society  
Morcharde Bishop Parish Council  
Buckland Brewer Parish Council  
Crediton Town Council

Hennock Parish Council  
Borough of Poole  
Newton Abbot Town Council (3 Beacons)  
Lifton Parish Council  
South Tawton Parish Council  
Okehampton Hamlets Parish Council  
Chagford Parish Council  
Strete Parish Council  
Peter Tavy Parish Council  
Newton Poppleford and Harpford Parish Council  
Bideford Town Council  
Clifford Estate Company Ltd & Chudleigh Town Council  
Luppitt Parish Council  
Burrington Parish Council  
Holsworthy Town Council  
Dawlish Town Council

## DORSET

Portland Bill - Trinity House  
Sturminster Newton Town Council  
Bournemouth Council  
Beaminster Town Council  
Bere Regis Parish Council  
Charmouth Parish Council  
Borough of Poole  
Bridport Town Council  
Silton Parish Meeting  
Ferdowdown Town Council, St Mary's Church & Ferdowdown Royal British Legion  
Hambury Tout/The Lulworth Estate  
Stratton (Dorset) Parish Council  
Allington Hill, Cooper's Field and Wood Community Group

## EAST & WEST SUSSEX

Crowborough Town Council  
Community of Brightling Village  
Wave Leisure Trust Ltd  
Shining Lights (Bexhill Ltd)

Winchelsea Artefacts Society  
Crawley Borough Council  
1st Horam Scout Group & Horam Parish Council  
Alfriston Parish Council  
Burwash Parish Council  
Northiam Parish Council  
Hamsey Parish Council & East Chiltoning Parish Council  
Willingdon and Jevington Parish Council  
Milland Parish Council  
Uckfield Town Council  
Hooe Parish Council  
Bognor Regis Town Council  
Heathfield and Waldron Parish Council  
Newick Parish Council with Newick Bonfire Society  
Southbourne Sea Scouts  
Littlehampton Town Council  
Twineham Parish Council  
Burgess Hill Town Council  
Worthing Borough Council  
Friends of Shoreham Fort

## EAST YORKSHIRE

Rowley Parish Council  
Sutton upon Derwent Parish Council  
Market Weighton Town Council  
Kilpin Parish Council  
Hessle Town Council  
Sancton All Saints Church PCC  
Withernsea Town Council  
Hedon Town Council  
Beverley Town Council  
Rawcliffe Parish Council  
Bishop Buirton Parish Council  
Withernsea Town Council  
North Ferriby Parish Council  
Skerne and Wansford Parish Council



# Acknowledgements

## ESSEX

Broxted Parish Council  
White Colne Parish Council  
Burnham-on-Crouch Town Council  
Wivenhoe Town Council  
Harwich Pier - Trinity House  
St Lawrence Parish Council  
Rochford District Council  
Ingatestone and Fryerning Parish Council  
Waltham Abbey Town Council  
Harwich Society  
High Easter Parish Council  
St Lawrence PCC  
Maldon District Council  
West Bergholt Parish Council  
Loughton Town Council  
Billericay Town Council  
Great Bentley Parish Council  
Great Canfield Parish Council  
Colchester Borough Council  
Great Totham Parish Council  
Margaret Roding Parish Council  
Little Easton Parish Council  
Ilford East Scout District  
Alphamstone & Lamarsh Parish Council  
Thaxted Parish Council  
Thurrock Council & Coalhouse Fort

## GLOUCESTERSHIRE

Girlguiding Gloucestershire  
Wotton Under Edge & District Round Table  
Stow on the Wold Town Council  
Lydney Town Council  
Cheltenham Trust & Cheltenham Town Hall  
Wickwar Parish Council  
Oldbury on Severn Parish Council  
Windrush Parish Meeting  
Adlestrop Village  
St Edward's Evenlode PCC  
Patchway Town Council  
Siston Parish Council  
Downend & Bromley Heath Parish Council

## GREATER MANCHESTER

Stockport Metropolitan Borough Council  
Tameside Council & Tameside Armed Services  
Community  
Manchester Cathedral  
Bolton Council

## HAMPSHIRE

East Meon Parish Council  
Odiham Parish Council  
Liss Parish Council  
Candovers Parish Council  
Portsmouth City Council  
Bramley Parish Council  
Damerham Parish Council  
Denmead Parish Council  
Hythe Marina Centre  
West End Parish Council  
Bishop's Waltham Parish Council  
Hythe and Dibden Parish Council  
Overton Parish Council  
Hurst Castle - (English Heritage)  
Porchester Castle - (English Heritage) in  
association with Fareham Borough Council  
New Milton Town Council, New Milton Lions &  
Royal British Legion

## HEREFORDSHIRE

Hereford City Council  
Ross-on-Wye Town Council

## HERTFORDSHIRE

Benington Recreation Ground Charity Trust  
Hormead Community Group  
St Stephen Parish Council  
Highfield Park Trust  
Stevenage Borough Council  
Hertfordshire County Council  
Shenley Parish Council  
Perry Green and Green Tye Preservation  
Society

Welwyn Hatfield Borough Council  
St Albans City and District Council  
Furneaux Pelham Hall  
Woodcock Hill Village Green Committee  
(WHVG)

## ISLE OF WIGHT

St Catherine's Lighthouse, Southern Tip of the  
Isle of Wight - Trinity House  
The Royal British Legion - Isle of Wight  
County Committee  
Carisbrooke Castle - (English Heritage)

## KENT

East Peckham Parish Council  
Temple Ewell Parish Council  
Hildenborough Parish Council  
Canterbury City Council  
Westenhanger Castle & Stanford Parish Council  
8th Sheppey Scout Group  
Dymchurch Parish Council  
North Foreland - Trinity House  
Petham Village  
Yalding Parish Council  
River Parish Council  
Benenden Parish Council  
Hawkhurst Parish Council  
Chislet Parish Council  
Rusthall Parish Council  
Aldington and Bonnington Parish Council  
Saint Peter and Saint Paul's Church -  
Farningham  
Snodland Town Council  
St Nicholas-at-Wade & Sarre Parish Council  
Lyminge Parish Council  
Lydd Town Council  
Hever Residents Association and Hever Parish  
Council  
Bidborough Parish Council  
Broadstairs & St Peter's Town Council  
10th Deal Eastry Scouts  
Ashford Borough Council

Friends of Capel Church  
Badlesmere Parish Hall  
Great Chart Remembers - Great Chart  
Eastry Parish Council  
Tenterden Town Council  
Birchington Parish Council  
Borough Green Parish Council  
Plaxtol Parish Council  
New Romney Town Council  
Hartlip Parish Council  
Dover Town Council  
Newchurch Parish Council  
Woodnesborough Parish Council  
Lamberhurst Parish Council  
Chilham Parish Council  
Egerton Parish Council  
The Three Suttons and Sutton Valence &  
District Branch RBL  
Stockbury Parish Council  
Hartley Parish Council  
Detling Parish Council  
Hoo St Werburgh Parish Council  
Leeds Parish Council  
Wye with Hinxhill Parish Council  
Harrietsham Parish Council  
Wickhambreaux Parish Council  
Mersham and Sevington Parish Council  
Westerham Town Council  
Horton Kirby and South Darent Parish  
Council  
Staplehurst Parish Council  
Westwell Parish Council  
Newington History Group - Newington  
Dover Castle - (English Heritage)  
Longfield and New Barn Parish Council  
Appledore Local History Society  
Teston Parish Council  
Cranbrook & Sissinghurst Parish Council  
Cliffe and Cliffe Woods Parish Council  
Ash-cum-Ridley Parish Council  
Crundale Parish Council



# Acknowledgements

## LANCASHIRE

Staining Parish Council  
Earby Town Council  
West Lancashire Borough Council  
Whittington Parish Council  
Wyre Council  
Chorley Council  
Fylde Borough Council  
Lancaster City Council  
Pilling Parish Council  
Duchy of Lancaster - Lancaster Castle & Lancaster City Council  
Whitworth Town Council  
West Bradford Parish Council  
Grindleton Parish Council  
Bretherton Parish Council  
Bold Parish Council  
Ribby with Wrea Parish Council & Westby with Plumpton Parish Council  
Little Ecclestone and Larbreck Parish Council  
Preesall Town Council  
Slaidburn & Easington Parish Council  
Warton Parish Council  
Whittle-le-Woods and Clayton-le-Woods War Memorial Committee  
Mellor Parish Council  
Whittle-le-Woods Parish Council  
Catforth Village Memorial Hall  
Rochdale Borough Council

## LEICESTERSHIRE

Husbands Bosworth Parish Council  
Leicestershire County Council  
Fleckney Parish Council  
Great Easton Parish Council  
Broughton Astley Parish Council  
Ashby de la Zouch Town Council  
Thorpe Acre Scout Group  
Barkby and Barkby Thorpe Parish Council  
Earl Shilton Town Council

Hinckley and Bosworth Borough Council  
Breedon on the Hill Parish Council  
Twyford Recreation Ground  
Glenfield Parish Council

## LINCOLNSHIRE

International Bomber Command Centre  
Worlaby Parish Council  
Hibaldstow Parish Council  
Elsham Parish Council  
Corby Glen Parish Council  
Haxey Parish Council  
Pinchbeck Parish Council & St. Mary's Church  
Deeping St James Parish Council  
Stapleford Parish Meeting  
Metheringham, Sots Hole and Tanvats Parish Council  
Epworth Town Council  
Scopwick and Kirkby Green Parish Council  
Scrivelsby Estate  
North East Lincolnshire (3 Beacons)  
Louth Town Council  
Barrowby Parish Council  
Crowland Parish Council  
Collyweston Parish Council  
Elsham Parish Council

## LONDON

Merchant Navy Association National Memorial - Tower Hill, London  
Royal Borough of Greenwich (3 Beacons)  
Barnet Borough Scouts  
London Borough of Havering  
Ealing Council  
London Borough of Islington  
London Borough of Camden

## MERSEYSIDE

Billinge Chapel End Parish Council  
Cronton Parish Council

## NORFOLK

Thorpe St Andrew Town Council  
Potters Leisure Resort  
Melton Constable Parish Council  
Cromer - Trinity House  
The Greyhound Inn - Hickling  
Shouldham Parish Council  
Ashill Parish Council  
Norfolk Tank Museum  
Lingwood and Burlingham Parish Council  
Wells Harbour Commissioners  
Honing Village Hall  
Thetford Town Council  
Claxton Parish Council  
Letheringsett with Glandford Parish Council  
Wiveton Parish Council  
Downham Market Town Council  
Ashwellthorpe and Fundenhall Parish Council  
Overstrand Parish Council  
Necton Parish Council  
Marshland St James Parish Council  
Walpole Cross Keys Parish Council  
Barton Bendish Parish Council  
Swanton Novers Parish Council  
Langham Parish Council  
Norwich City Council  
Great Yarmouth Borough Council  
Rollesby Parish Council  
Blakeney Parish Council  
Surlingham Parish Council  
Dersingham Parish Council  
Attleborough Town Council  
Garvestone, Reymerton & Thuxton Parish Council  
Hockham Parish Council  
Wood Norton Parish Council  
Beeston Regis Parish Council  
Repps with Bastwick  
Chedgrave Parish Council  
Hoveton Parish Council  
Hardingham Parish Council and Village Hall Committee

Acle Bridge Inn, Acle  
Great Massingham Parish Council  
Tittleshall Parish Council  
Norfolk District Council  
Heacham Parish Council  
Stoke Ferry Parish Council  
Dickleburgh & Rushall Parish Council  
Northrepps Parish Council  
Fincham Parish Council  
West Dereham Parish Council  
Broome Parish Council  
Morston Parish Council  
North Norfolk District Council & Cromer Town Council  
Kelling Parish Council  
Fakenham Town Council  
Sheringham Town Council  
Hardingham Parish Council

## NORTHAMPTONSHIRE

Thrapston Town Council  
Corby Borough Council  
Little Addington Parish Council  
Raunds Town Council  
Farthinghoe and Steane Parish Council  
Brackley Town Council  
Irthlingborough Town Council  
Northamptonshire County Council & All Saints' Church  
Crick Parish Council  
Grendon Parish Council  
Harlestone Parish Council  
Duston Parish Council  
Cogenhoe and Whiston Parish Council  
Litchborough Parish Council  
Cold Higham Parish Council  
Whittlebury Parish Council  
Helmdon Parish Council  
Bozeat Parish Council  
Denton Parish Council





# Acknowledgements

## **NORTHUMBERLAND**

Heugh Hill (Holy Island) - Trinity House  
Morpeth Town Council  
Amble Town Council  
Ford & Etal Estates with the North  
Northumberland Branch of The Royal British Legion  
Lindisfarne Priory - (English Heritage)  
Housesteads Roman Fort - (English Heritage)  
Berwick-upon-Tweed Barracks - (English Heritage)

## **NORTH YORKSHIRE**

Richmond Town Council  
West Tanfield Committee  
Danby Beacon Trust  
Bentham Town Council  
Masham Parish Council  
Spofforth with Stockeld Parish Council  
Skipton Town Council  
Bewerley Parish Council  
Tadcaster Town Council  
Tan Hill Inn (HIGHEST PUB IN GREAT BRITAIN)  
Barlby and Osgogby Town Council  
Leavening Parish Council  
Settle Town Council  
Goldsborough Hall  
Willerby Parish Council  
Riccall Parish Council  
Dalton on Tees Parish Council  
Gateford Parish Council  
Langthorpe Parish Council  
Wistow Parish Council  
Askham Richard Parish Council  
Rudby Parish Council  
Burton in Lonsdale Parish Council  
Whitley Parish Council  
Escrick Parish Council  
Sherburn Parish Council  
Clapham cum Newby Parish Council

Eskdaleside cum Ugglebarnby Parish Council  
Knaresborough Town Clerk  
Scagglethorpe Parish Council  
Baldersby & Baldersby St James Parish Council  
Great Ayton Parish Council  
Darley & Menwith Parish Council  
Settringham Parish Council  
Long Preston Parish Council  
Rawcliffe Parish Council  
Middleham Town Council  
Thirsk Royal British Legion in association with the Rotary Club of Thirsk  
Scarborough Castle - (English Heritage)  
Richmond Castle - (English Heritage)  
Whitby Abbey - (English Heritage)  
Pickering Castle - (English Heritage)  
Middleham Castle - (English Heritage)  
Rocliffe & Westwick Parish Council  
Sneaton Village Community in association with Beacon Farm, supported by Sneaton Parish Council  
Tanfield Parish Council  
Bilbrough Parish Council  
Easingwold Town Council  
Upper and Nether Poppleton Parish Councils  
Copmanthorpe Parish Council

## **NOTTINGHAMSHIRE**

Nottingham City Council  
Kimberley Town Council  
Clarbrough and Welham Parish Council  
Flintham Parish Council  
Costock Parish Council  
Bunny Parish Council  
Wysall Parish Council  
Willoughby on the Wolds Parish Council  
Elston Parish Council  
Collingham Parish Council  
Nottingham City Council  
Normanton on the Wolds Parish Council

Shelford Parish Council - Nottinghamshire  
Plumtree Parish Council  
East Stoke Parish Council  
Whatton in the Vale Parish Council  
Thurgarton Parish Council  
Stanton on the Wolds Parish Council  
East Markham Parish Council

## **OXFORDSHIRE**

Wootton Memorial Playing Field Committee  
Abingdon-on-Thames Town Council  
Swinbrook & Widford Parish Council  
Upper Lea Farm  
Vale of White Horse & Faringdon Town Council  
Brightwell Baldwin Parish Meeting  
Lockinge Estate with Ardington & Lockinge Parish Council  
The Bix Branch of The Royal British Legion  
Greatworth Parish Council  
Swyncombe Parish Council  
Banbury Town Council  
Thame Town Council  
Clanfield Festival

## **RUTLAND**

Rutland County Council  
Barrowden

## **SHROPSHIRE**

Clive Parish Council  
Burwarton Estates  
Sibdon Parish Meeting  
Whixall Parish Council  
Cound Parish Council  
Ightfield and Calverhall Parish Council  
Much Wenlock Town Council  
Bayston Hill Parish Council & Bayston Hill Scouts  
Lights Out Trefonen  
Ruyton XI Towns Parish Council

## **SOMERSET**

North Somerset Council  
Sedgemoor District Council  
AH Trollope-Bellew  
Long Ashton Community Association Somerset  
Peasedown St John Parish Council  
Kingsdon Parish Council  
Everard Family - Broford Farm  
Trull Parish Council  
Midsomer Norton Town Council  
Cucklington Parish Meeting  
Williton Parish Council  
Priddy Parish Council & Priddy Friendly Society  
Chard Town Council  
Clatworthy Parish Council  
Priston Parish Council  
St Cuthbert (Out) Parish Council  
Ilminster Town Council  
Dunkerton & Tunley Parish Council  
Uphill Village Society  
Banwell Parish Council  
Stawell Village Hall Committee

## **SOUTH YORKSHIRE**

Tickhill Town Council  
Hunshelf Parish Council  
Charles & Rosalind Buckler  
Tankersley Parish Council  
Sheffield Vulcan Rotary Club  
Hellaby Parish Council  
Austerfield Parish Council  
Penistone Agricultural Show  
Wales Parish Council  
Burghwallis Parish Council  
Sykehouse Parish Council  
Brinsworth Parish Council  
Wadworth Village Hall Committee  
Conisbrough Castle - (English Heritage)  
Armthorpe Parish Council  
Fwd Martha's Yard Hoylands Community Garden



# Acknowledgements

## **STAFFORDSHIRE**

Lichfield City Council  
Cheddleton & Wetley Rocks Parish Council  
Parish of Quinton & Admington  
Endon with Stanley Parish Council  
Cannock Chase Council  
Stone Town Council  
Rugeley Town Council  
Loggerheads Parish Council  
Kingsley Parish Council  
Dilhorne Recreation Centre  
Hixon Millennium Green Trust  
Croxden Parish Council  
Bishops Offley Millennium Green Trust  
Colwich Parish Council

## **SUFFOLK**

West Row Village War Memorial, West Row  
Bures St Mary Parish Council & Bures Royal  
British Legion  
Dukes Head - Somerleyton  
Levington and Stratton Hall Parish Council  
Orford & Gedgrave Parish Council  
Mendlesham Parish Council  
Sudbury Town Council  
Nacton Community Council  
Waveney District Council  
Little Thurlow and Great Thurlow Parish  
Councils  
Friston Parochial Church Council  
Ipswich Borough Council  
Metfield Parish Council  
Alderton Parish Council  
Burstall Parish Council  
Sproughton Parish Council  
Holton St Mary Village  
Barnham Parish Council  
Beccles Town Council  
Kedington Parish Council and Kedington &  
District Branch Royal British Legion  
Haverhill Town Council

Aldeburgh Town Council  
Glemham Hall Events & Little Glemham Parish  
Council  
Woodbridge Town Council  
Laxfield Parish Council  
Cockfield Parish Council  
Woolverstone Village with Woolverstone  
Parish Council & Ipswich High School for Girls  
Great Bealings Parish Council  
Bungay Town Trust  
Woolpit Parish Council  
Boxford Community Council  
Kirton & Falkenham Parish Council  
Beck Row, Holywell Row & Kenny Hill Parish  
Council  
Whepstead Community Association  
Benhall & Sternfield Parish Council  
Clare Community Association (CCA)  
Brent Eleigh Parish Council  
Badingham Parish Council  
Capel St Mary War Memorial Trust  
Hepworth Parish Council  
Rushmere St Andrew Parish Council  
Norton Parish Council  
Kettlebaston Parish Council  
Hitcham Parish Council  
Wissett Parish Council with Wissett  
Community Council & Church Councils  
Great Ashfield Parish Council  
Kesgrave Town Council  
Combs Parish Council  
Melton WWI Heritage Group  
Great and Little Wheltenham Parish Council  
Henley Parish Council/Henley Community  
Centre

## **SURREY**

Farnham Castle  
Caterham Festival Committee  
West End Parish Council  
Normandy Parish Council

Guildford Borough Council & Guildford Lions  
Clubs  
Reigate and Banstead Borough Council  
Worplesdon Parish Council  
Royal British Legion (Pirbright Branch)  
Lingfield Parish Council  
Dormansland Parish Council  
Cranleigh Parish Council

## **TYNE AND WEAR**

Tynemouth Priory

## **WARWICKSHIRE**

Royal Leamington Spa Town Council  
Stratford-upon-Avon Town Council &  
Stratford-upon-Avon District Council  
Snitterfield Parish Council  
Fillongley Parish Council  
Harbury Parish Council  
Bishop's Itchington Parish Council  
Salford Priors Parish Council  
Hepkirk Parish Council  
Coleshill Town Council  
Ansty Parish Council  
Budbrooke Parish Council  
Leek Wootton & Guy's Cliffe Parish Council  
Wolvey Parish Council  
Upper and Lower Quinton

## **WEST MIDLANDS**

St Stephen's Church - Rednal  
Birmingham City Council  
Solihull Metropolitan Borough Council  
St. Peters Collegiate Church - Wolverhampton  
Wythall Community Association

## **WEST YORKSHIRE**

Wakefield Metropolitan District Council  
Strathmore/Blackshaw Parish  
Hebden Royd Town Council  
Clifford Parish Council

Hemsworth Town Council  
Emley Millennium Green  
Normanton Town Council  
Collingham with Linton Parish Council  
Kippax British Legion & Kippax Parish Council  
R&CP Haigh and Sons  
Barwick in Elmet Parish Council  
Scholes Parish Council  
Woolley Village Residents Association  
Baldon Town Council

## **WILTSHIRE**

Manorial Court for the Hundred & Borough of  
Cricklade  
Steeple Ashton Bellringers  
Semington Village  
Sutton Benger Village Hall & Recreation  
Ground Charity  
Westbury Town Council  
Stanton Saint Bernard Parish Council  
Amesbury Town Council  
Stratton St Margaret Parish Council  
Stonehenge - (English Heritage)  
Compton Bassett Parish Council  
Coberley Parish Council

## **WORCESTERSHIRE**

Worcestershire County Council  
Severn End Estate  
Ripple Parish Council & Great Mongeham  
Parish Council  
Hindlip, Martin Hussingtree & Salwarpe Parish  
Council  
Romsley Parish Council  
Kempsey Parish Council  
Overbury Enterprises  
Rock Parish Council  
Hanley William, Hanley Broadheath & Hanley  
Childe Parish/Edward Yarnold  
Clent Parish Council



# Acknowledgements

## CHANNEL ISLANDS & ISLE OF MAN

**SARK**  
**STATES OF ALDERNEY**  
**STATES OF GUERNSEY**  
**STATES OF JERSEY**

## ISLE OF MAN

Isle of Man Government  
Isle of Man Civil Defence

## NORTHERN IRELAND

St Macartin's Cathedral (MOST WESTERLY CATHEDRAL IN THE UNITED KINGDOM)  
Antrim and Newtownabbey Borough Council (2 Beacons)  
Ards and North Down Borough Council (3 Beacons)  
Armagh City, Banbridge and Craigavon Borough Council  
Mid & East Antrim Borough Council  
Lisburn & Castlereagh City Council

## SCOTLAND

Aberdeen City Council  
Argyll Estates  
West Lothian Council  
North Ayrshire Council  
The Royal Burgh of Annan Community Council & Annan Branch of the Royal British Legion  
Renfrewshire Lieutenancy  
Unst Community Council (MOST NORTHERLY INHABITED ISLAND IN THE UK)  
The National Trust for Scotland  
Colpy/Culsalmond (Williamston Estates)

Clackmannanshire Council  
Meldrum and Bourtie Community Council  
Old Rayne Community Association  
Cringletie Farm  
Culross Community Council  
Royal Naval Association Rosyth & West Fife Branch  
Port William Community Association Scio  
Legion Scotland Hawick Branch

## WALES

St Davids City Council (THE MOST WESTERLY CITY IN WALES)  
Amroth Village / Amroth Arms  
Mumbles Community Council  
St Anne's Head - Trinity House  
Newport City Council  
St Mary Hill Church  
Carmarthen Town Council  
Llangynidr Beacon Committee  
Wrexham County Borough Council  
Cowbridge with Llanblethian Town Council  
Beaumaris Town Council  
Welshpool Town Council (2 Beacons)  
Magor with Undy Community Council  
Fishguard and Goodwick Town Council  
Menai Bridge Town Council  
Penhow Community Council  
Martletwy Community Council  
Llandefalle Hall Committee  
Penally Community Council  
Pembrey and Burry Port Town Council  
Usk Town Council  
Portskewett Community Council  
Whitton Community Council  
Caernarfon Royal Town Council  
Narberth Town Council  
Llansteffan and Llanybri Community Council

Saundersfoot Community Council  
Montgomery Town Council  
Rhayader Town Council  
Langstone Community Council  
Llanwenog Community Council  
Rhuddlan Town Council  
Bridgend Town Council  
Cyngor Cymuned Dolbenmaen (Dolbenmaen Community Council)  
Llantwit Major Town Council  
Shirenewton Community Council (Monmouthshire)  
Dyffryn Cennen Community Council  
The Havens Community Council  
Cyngor Tref Criccieth Town Council  
Abergwyngregyn Village, Gwynedd  
Llanfair Clydogau Village Hall Committee  
Llanfihangel Rhydithon Community Council  
Mawr Community Council  
Abergavenny Town Council  
Abetillery and Llanhilleth Community Council  
Aberporth Community Council  
Haverfordwest Town Council  
Cyngor Tref Tywyn/Tywyn Town Council  
Fairfield Farm, Powys  
Llandudno Town Council - Conwy  
St Chads Church - Wrexham  
Girlguiding Caernarfonshire  
Amroth Community Council  
Machynlleth Royal British Legion - Powys  
Marloes Community Council - Pembrokeshire  
Neyland Town Council  
Llanelwedd Community Council  
Amlwch Group, Battle's Over  
Crynant Community Council  
Gwersyllt Community Council

## UNITED KINGDOM OVERSEAS TERRITORIES

Government of South Georgia & South Sandwich Islands  
St Helena - South Atlantic Ocean  
Ascension Islands Government  
Falkland Islands Council  
Tristan da Cunha  
Government of the Virgin Islands  
Government of Bermuda  
Pitcairn Island



# *Sleep in Peace, now the Battle's Over* *Acknowledgements*

We would very much like to thank all of those that have helped make this aspect of 'Battle's Over' a reality.

## **Participating Cathedrals, Minster Churches and others.**

### **ENGLAND**

#### **Bath**

Bath Abbey  
Bristol & Gloucester Wing, Air Trains Corps

#### **Blackburn**

Blackburn Cathedral  
Acrington Pipes and Drums (The oldest Pipe Band in the World)

#### **Birmingham**

Birmingham Cathedral  
West Midlands Fire Service Pipe Band

#### **Bradford**

Bradford Cathedral  
City of Bradford Pipe Band

#### **Bristol**

Bristol Cathedral  
Royal Marines Reserve  
Name of Piper: Piper Robert Cunningham

#### **Brighton and Hove**

St Nicholas Church  
Sussex Wing, Air Training Corps

#### **Bury St Edmunds**

The Cathedral Church of St James and St Edmund  
Norfolk & Suffolk Wing, Air Training Corps

#### **Cambridge**

King's College Chapel  
Cambridgeshire Caledonian Pipe Band

#### **Canterbury**

Kent Wing, Air Training Corps

#### **Carlisle**

Carlisle Cathedral  
Army Cadet Force

#### **Chelmsford**

Chelmsford Cathedral  
Name of Piper: Jonathan Swan (Member of the congregation)

#### **Chester**

Chester Cathedral  
Army Cadet Force

#### **Chichester**

Chichester Cathedral  
Army Cadet Force

#### **Coventry**

Coventry Cathedral  
Shirley Pipe Band  
Name of Piper: Dr Rodger Patrick BA

#### **Derby**

Derby Cathedral  
Army Cadet Force

#### **Durham**

Durham Cathedral  
Air Training Corps

#### **Ely**

Ely Cathedral  
RAF Waddington Pipes and Drums

#### **Exeter**

Exeter Cathedral  
City of Exeter Pipes and Drums

#### **Gloucester**

Gloucester Cathedral  
St Andrew's Pipe Band of Cheltenham

#### **Great Yarmouth**

Great Yarmouth Town Hall  
Air Training Corps

#### **Guildford**

Cathedral Church of the Holy Spirit  
Guildford Cathedral  
Gordons School Combined Cadet Force

#### **Hereford**

Hereford Cathedral  
Professor Alan Harrison

#### **Kingston upon Hull**

Holy Trinity Church  
Beverley and District Pipe Band

#### **Lancaster**

St Peter's Catholic Cathedral  
Army Cadet Force

#### **Leeds**

Cathedral Church of St Anne  
City of Leeds Pipe Band

#### **Leicester**

Leicester Cathedral  
RAF Waddington Pipes and Drums

#### **Lichfield**

Lichfield Cathedral  
Piper Stuart Maclaughlan

#### **Lincoln**

Lincoln Cathedral  
RAF Waddington Pipes and Drums

#### **Liverpool**

Liverpool Cathedral  
Liverpool Clan Wallace Pipe Band  
Name of Piper: Pipe Major Robbie Blackmore  
(Will be 70 year's old in 2018)

#### **London**

St Paul's Cathedral, City of London  
Sussex Wing, Air Training Corps

Westminster Abbey, Westminster, London  
Sussex Wing, Air Training Corps



# Acknowledgements

The Queen's Chapel of the Savoy, Savoy Hill,  
Strand, London  
Sussex Wing, Air Training Corps

RAF Memorial, Victoria Embankment, Victoria,  
London  
Sussex Wing, Air Training Corps

National Merchant Navy Memorial, Trinity  
Square Gardens, Tower Hill, London  
Sea Cadet Corps

## **Manchester**

Manchester Cathedral  
Name of Piper: Piper Neil MacDonald

## **Norwich**

Norwich Cathedral  
City of Norwich Pipe Band  
Name of Piper: Piper David Harper

## **Newcastle Upon Tyne**

St Nicholas Cathedral  
North Tyneside Pipe Band

## **Nottingham**

Cathedral Church of St Barnabas  
RAF Waddington Pipes and Drums

## **Oxford**

Christ Church  
Oxford Caledonian Pipes and Drums  
Name of Piper: Piper H. P. Smith

## **Peterborough**

Peterborough Cathedral  
Peterborough Highland Pipe Band

## **Plymouth**

Plymouth Catholic Cathedral  
Sea Cadet Corps

## **Portsmouth**

Portsmouth Cathedral  
Hampshire Caledonian Pipe Band

## **Preston**

The Minster and Guild Church of St John the  
Evangelist  
City of Preston Pipes and Drums

## **Ripon**

Ripon Cathedral  
CE Yorkshire Wing, Air Trains Corps

## **Rochester**

The Cathedral Church of Christ and the  
Blessed Virgin  
City of Rochester Pipe Band  
Name of Piper: Piper Major Tony Daniel

## **Salford**

Church of St John the Evangelist

## **Salisbury**

Salisbury Cathedral  
RAF Waddington Pipes and Drums

## **Sheffield**

The Cathedral Church of St Peter and St Paul  
City of Sheffield Pipe Band

## **Southampton**

Hampshire Caledonian Pipe Band

## **Stoke on Trent**

Stoke Minster

## **St Albans**

St Albans Cathedral

## **Sunderland**

Sunderland Minster

## **Truro**

Truro Cathedral  
RAF Waddington Pipes and Drums  
Army Cadet Force

## **Wakefield**

Wakefield Cathedral

## **Wells**

Wells Cathedral

## **Winchester**

Winchester Cathedral  
Hampshire Caledonian Pipe Band

## **Wolverhampton**

St Peter's Collegiate Church

## **Worcester**

Worcester Cathedral

## **York**

Mansion House, St Helen's Square  
RAF Waddington Pipes and Drums

## **SCOTLAND**

### **Aberdeen**

St Mary's Catholic Cathedral  
The National Youth Pipe Band of Scotland

### **Dundee**

St Paul's Cathedral  
The Mackenzie Caledonian Pipe Band  
Name of Piper: Piper Major Neil Nicholson

### **Edinburgh**

St Mary's Episcopal Cathedral  
The National Youth Pipe Band of Scotland

## **Glasgow**

Glasgow Cathedral  
The National Youth Pipe Band of Scotland

## **Holyrood**

Church of the Holyrood  
South East Wing Air Training Corps

## **Inverness**

St Andrew's Cathedral  
1st Battalion the Highlanders  
Name of Piper: Pipe Major Calum Mackenzie

## **Perth**

Perth Cathedral, St Ninian's  
The National Youth Pipe Band of Scotland

## **Stirling**

Church of the Holy Rude

## **WALES**

### **Cardiff**

Cardiff Metropolitan Cathedral of St David  
Army Cadet Force

### **Newport**

St Woolos' Cathedral  
Newport Cathedral  
Army Cadet Force

### **St Davids**

St Davids Cathedral  
Army Cadet Force

### **Swansea**

St Joseph's Cathedral  
Army Cadet Force



# Acknowledgements

## NORTHERN IRELAND

### Armagh

Cathedral Church of St Patrick  
1st and 2nd Battalion Army Cadet Force (N.I.)

### Belfast

St Anne's Cathedral  
1st and 2nd Battalion Army Cadet Force (N.I.)

### County Down

Cathedral Church of the Holy Trinity, 1st  
Battalion Army Cadet Force (N.I.)  
Cathedral Church of Christ the Redeemer, 1st  
& 2nd Battalion Army Cadet Force (N.I.)

### Derry

St Columb's Cathedral  
1st and 2nd Battalion Army Cadet Force (N.I.)

### Downpatrick

Cathedral Church Of The Holy Trinity  
1st and 2nd Battalion Army Cadet Force (N.I.)

### Dromore

Cathedral Church Of Christ The Redeemer  
1st and 2nd Battalion Army Cadet Force (N.I.)

### Enniskillen

St Macartin's Cathedral  
1st and 2nd Battalion Army Cadet Force (N.I.)

### Lisburn

Cathedral of Christchurch  
1st and 2nd Battalion Army Cadet Force (N.I.)

### Newry

1st and 2nd Battalion Army Cadet Force (N.I.)

## ISLE OF MAN

Cathedral Isle of Man  
Ellan Vannin Pipes and Drums  
Name of Piper: Pipe Major John Struthers

## CHANNEL ISLANDS

### Jersey

Town Church, St Helier  
Jersey Pipe Band  
Name of Piper: Pipe Sergeant David Reid

## BELGIUM

### Ypres

Ypres and Surrey Pipes and Drums

## OTHER PIPERS TAKING PART THROUGHOUT THE WORLD

**The City of Norwich Pipe Band, Norwich,  
Norfolk, England, were the first Band in  
the world to confirm that all their their  
pipers would be taking part in the playing  
of 'Battle's O'er' at 6am on 11th  
November 2018, at individual locations in  
their area.**

Piper Robert Gunther - Location: Memorial  
Square, USA Army Base, Wiesbaden,  
GERMANY  
Piper Alexandra Greenwood - Location: 3  
Forge Road, Are, SCOTLAND  
Piper Dennis Duncan - USA National  
Cemetery, Marietta, Georgia, USA  
Piper J Anderson - Location: Weedon Bec  
Memorial, Northampton, ENGLAND  
Piper Michael Bates - Saint Wilfred Church,  
Pevensey Bay, East Sussex, ENGLAND

Piper Anne Lore - Location: War Memorial,  
Place Du Commando, Saint-Nazaire, FRANCE  
Piper Randall Stiles - Location: Church in  
Texas, USA  
Piper Adrian Vaughan - Location: Iowa, USA  
Piper Brian Baldwin - Location: Des Moines,  
USA  
Piper Dawn Baldwin - Location: Des Moines,  
USA  
Piper Jim Dawson - Location: Woodside, of  
Balhaldie, Braco, Dunblane, NORTHER  
IRELAND  
Piper Timothy J O Gatehouse: Location:  
2809Broad Avenue, Altoona, USA  
Piper Kevin Walker - Location: Cefn Cribwr  
War Memorial, Cefn Cribwr, South Wales  
Piper Anne Betty - Location: Blackburn  
Cathedral, Blackburn, Lancashire, ENGLAND  
Piper Douglas Watson - Location: TBC  
Piper Lisa DeMerchant - Location: TBC  
Piper Al Hunter - Location: Munloch War  
Memorial, Inverness-shire, Highland,  
SCOTLAND  
Piper Bud Miller - Location: TBC  
Piper Mark Jackson - Location: 1, Barnton  
Place, Dumfries, SCOTLAND  
Piper Fletcher Haley - Location: Poppy  
Garden, London, ENGLAND  
Piper Frank Anderson - London: Cenotaph,  
Brantford, Ontario, CANADA  
Piper Paul McGowan - Location: TBC  
Piper Laurence Ching - Location: TBC, Texas,  
USA  
Piper Jennifer S R Hutcheon - Location: TBC  
Piper Jeff Forrester - Location: Walmart,  
Abingdon, Tennessee, USA  
Piper Robbie Barrett - Location: TBC  
Piper Richard Scott - Location: Craigclowan  
School, Perth, Perth & Kinross, SCOTLAND

Piper Dan Kelley - Location: West Linn,  
Oregon, USA  
Piper John Atkinson-Millmoor - Location:  
Stanhope, County Durham, ENGLAND  
Piper Nick Reeves - Location: TBC  
Piper Alexi Guretzke - Location: Castle  
Ehrenbreitstein, Koblenz, GERMANY  
Piper John Innes - Location: TBC  
Piper Tim Fountain - Location: TBC  
Piper David Brown - Location: In the bush of  
Northern Ontario while hunting, Ontario,  
CANADA  
Piper Desmond Davidson: Location:  
Aghadowey Parish Church, Aghadowey,  
Coleraine, Northern Ireland  
Piper Diron Cundiff - Location: TBC  
Piper Jimmie Innes - Location: RNLI Lifeboat  
Station, Lytham, Lancashire, ENGLAND  
Piper Tommy Nimmo - Location: Abercorn  
Church, South Queensferry, West Lothian,  
SCOTLAND  
Piper Sylvia McBeal - Location: The Memorial,  
Station Road, Ashwell, Hertfordshire,  
ENGLAND  
Piper Martin McBeal - Location: The Memorial,  
Station Road, Ashwell, Hertfordshire,  
ENGLAND  
Piper Renaud Olgiati - Location: TBC,  
PARAGUAY  
Piper Rob Bellew - Location: Salado Museum,  
Main Street, Salado, Texas, USA  
Piper Kathleen Little - Location: Glen Oaks  
Cemetery, Oakville, Ontario, CANADA  
Piper Andrew Head - Location: Perth,  
AUSTRALIA  
Piper John Cavanaugh - Location: Maple  
Grove Cemetery, Lake, USA  
Piper Emmanuel Corbasson - Location:  
Battlefields of Somme, FRANCE



# Acknowledgements

Piper Donna Myles - Location: 89, Lilybank Crescent, Forfar, Angus, SCOTLAND  
Piper Michael Heaslip - Location: On a hill overlooking the sea, St Austell, Cornwall, ENGLAND  
Piper Patrick Rafferty - Location: Flushing Cemetery, New York, USA  
Piper Cheri Collett - Location: Canton, Georgia, USA  
Piper Serge Ropars - Location: Jallans, Eure-et-Loir, FRANCE  
Piper David Miller - Location: St Olaf's Cemetery, Kirkwall, Orkney Islands, ORKNEY  
Piper Rhory More - Location: War Memorial, Teston Village, Kent, ENGLAND  
Piper John English - Location: War Memorial, Van Neste Park, New Jersey, USA  
Piper Robin Bartholomew - Location: Winchester Cathedral, Winchester, ENGLAND  
Piper Robert L Roberts - Location: Long Island National Cemetery, Farmingdale, Atlantic Ocean, USA  
Piper David Boling - Location: Huntsville Madison County Memorial, Madison, Alabama, USA  
Piper Chris Earl - Location: TBC, AUSTRALIA  
Piper Peter Quinn - Location: Rosetta Church, KwaZulu-Natal, SOUTH AFRICA  
Piper Ray Murphy - Location: TBC, New Jersey, USA  
Piper Peter McMahon - Location: 100-02 159 Avenue, Queens, New York, USA  
Piper Matt van Klaveren - Location: Spijkenisse, NETHERLANDS  
Piper Michael F Bell - Location: Veterans' Memorial, Galloway, New Jersey, USA  
Piper Annie Faivre and Adore Bayart - Location: Fleurey-sur-Ouche, FRANCE  
Piper Heather Shelswell - Location: Orillia, Brechin, Ontario, CANADA

Piper Bruce Stephen - Location: TBC  
Piper Don Ormiston - Location: Victoria, AUSTRALIA  
Piper Alexandra Calum Bell - Location: TBC  
Piper Andrew Jack Bell - Location: TBC  
Piper Bobby Allen - Location: The Cenotaph, Muirhead, Chryston, North Lanarkshire, SCOTLAND  
Piper Roly Monague Jr - Location: TBC, Christian Island, Ontario, CANADA  
Piper Nigel Bell - Location: Claygate, Quarry Brae, Harlow, Canonbie, Dumfries & Galloway, SCOTLAND  
Piper Kevin Bunt - Location: TBC, Windsor, Ontario, CANADA  
Piper James A McGowan - Location: Cape Town Cathedral, Cape Town, South Africa  
Piper Robert Blackmore - Location: Liverpool Anglican Cathedral, Merseyside, ENGLAND  
Piper Jeffrey A Williams - Location: The United States Special Operations Command, MacDill Air Force Base, Florida, USA  
Piper John OBoyle - Location: The War Memorial, Broughton, Brigg, North Lincolnshire, ENGLAND  
Piper Maclean Harry - Location: TBC  
Piper Anthony Byrne - Location: TBC  
Piper Chuck Penny - Location: TBC, Orillia, Ontario, CANADA  
Piper Michelle Jewell - Location: Corby, Northamptonshire, ENGLAND  
Piper Mick Murray - Location: Corby, Northamptonshire, ENGLAND  
Piper Scott McNeil - Location: Tiny, Ontario, CANADA  
Piper Paul Patterson - Location: Cenotaph, Orillia Soldiers Memorial Hospital, Ontario, CANADA  
Piper Bob Salmon - Location: Wir Peerie House, Windmill Road, Bradfield, Essex, ENGLAND

Piper Mike Simmons - Location: 46 Hillside Gardens, Braintree, Essex, ENGLAND  
Piper Albert McGalliard - Location: TBC, Jones County, Georgia, USA  
Piper Andy Tasker - Location: Horsforth War Memorial, Horsforth, Leeds, Yorkshire, ENGLAND  
Piper Brian Ross - Location: TBC  
Piper Andrew Whitelaw - Location: Bristol, ENGLAND  
Piper David Danks - Location: Leeds, Yorkshire, ENGLAND  
Piper Dr Dan Hock OD - Location: Evergreen, Colorado, USA  
Piper Sergeant John Sturgeon - Location: 8 Acacia Avenue, Robbinsville, New Jersey, USA  
Piper Philip Duthie - Location: War Garden, Victoria Embankment, Nottingham, ENGLAND  
Piper Birger Milling Eriksen - Location: Sct. Jacobi Church, Kirkepladsen, Varde, DENMARK  
Piper Igor Obratzov - Location: War Memorial, Izmailovskiy Park, Moscow, RUSSIA  
Piper James Felder - Location: Manhattan, New York City, USA  
Piper Andrew Isaac - Location: 43 Echo Landing Road, Moultonborough, New Hampshire USA  
Piper Dale Romagnoli - Location: Ganges Harbour, Salt Spring Island, British Columbia, CANADA  
Piper Dave Law - Location: Sheerness, Kent, ENGLAND  
Piper David Wilson - Location: Sheerness, Kent, ENGLAND  
Piper Maurice Remillard - Location: 107 Amberjack Road, Groton, New London, USA  
Piper Adrian Vaughan - Location: Bridgend War Memorial, Bridgend, WALES

Piper Roland Rousselle - Location: Monument for the Dead, Allee de Grande, Fontaine, La Bouexiere, FRANCE  
Piper Eric Soriot - Location: Monument for the Dead, Allee de Grande, Fontaine, La Bouexiere, FRANCE  
Piper Richard Allison - Location: Veterans Memorial, Baraboo, Wisconsin, USA  
Piper Francois Bergez - Location: Amiens, Somme, FRANCE  
Piper Vaughan Grandin - Location: 13348 Foxhole Drive, Fairfax, USA  
Piper Sandy J Keith - Location: Perthshire, SCOTLAND  
Piper Willie Nicol - Location: Comrie War Memorial, USA  
Piper Andy Ballantyne - Location: 300 Las Vegas Blvd, Las Vegas, Clark, USA  
Piper Gareth Waddell - Location: Perth, AUSTRALIA  
Piper Paul Stevens - Location: Local Cenotaph, Luggershall, Southampton, Hampshire, ENGLAND  
Piper James Carmichael - Location: Phillip Marx Central Park, Tehachapi, California, USA  
Piper Mary Macpherson - Location: Cupar War Memorial, Fife, SCOTLAND  
Piper Robert (bob) Ash - Location: War Memorial, Warlingham, Surrey, ENGLAND  
Piper Russell Hurd - Location: TBC  
Piper Michael Krogmann - Location: Texas, USA  
Piper John Swanson - Location: 4395 Glidden Dr. Sturgeon Bay, Door County, USA  
Piper Finlay Scott - Location: Craigclowan School, Edinburgh Road, Perth, Perth & Kinross, SCOTLAND  
Piper Zoe Brumfield - Location: Forest Mississippi, USA



# Acknowledgements

Piper Alexander Brodie - Location: Dundee Police War Memorial, Bell Street, Dundee, SCOTLAND  
Piper Don Lewis - Location: Breage, Cornwall, ENGLAND  
Piper Phil Puls - Location: TBC  
Piper Paul Halkyard - Location: Tenerife, Canary Islands, SPAIN  
Piper Victoria MacKenzie - Location: Photo Cathedral of St James, Vancouver, Washington, USA  
Piper Kyle Dawson - Location: War Memorial, Maddison Square Park, New York City, USA  
Piper Stuart Letford - Location: War Memorial, Birnam, Perth & Kinross, SCOTLAND  
Piper Matthew J Tierney - Location: Delaware War Memorial, Delaware County Courthouse, Media, Pennsylvania, USA  
Piper Robert Aggus - Location: Township of Puslinch Remembrance Service, Aberfoyle, Ontario, CANADA  
Piper Derek Holdsworth - Location: TBC  
Piper Tony Hill - Location: 2216, Brookside Drive, Tarrant, Tarrant County, Texas, USA  
Piper Douglas Ratcliffe - Location: War Memorial, Bishop Auckland, Durham, ENGLAND  
Piper James R Gillies - Location: Bonnyrigg, Midlothian, SCOTLAND  
Piper Mark Schmidt - Location: TBC  
Piper Reg Scott - Location: Coldstream, British Columbia, CANADA  
Piper Stephen Cairney - Location: Duntocher, Clydebank, SCOTLAND  
Piper Colin K Gavin - Location: Naperville, Illinois, USA  
Piper John A (Jack) MacIsaac - Location: New Glasgow Park, Pictou County, Nova Scotia, CANADA  
Piper Joseph Brady - Location: North Carolina, USA

Piper Frank McGoldrick - Location: Rugby, Warwickshire, ENGLAND  
Piper Francis Whitehead - Location: Church Yard, Christ Church, Chester Road, Rossett, Wrexham, WALES  
Piper Marcia Like - Location: 1443 E, Washington Blvd, Pasadena, California, USA  
Piper Andrew Walley - Location: War Memorial, outside St Helen's Church, Etwell, Derbyshire, ENGLAND  
Piper Keith Davey - Location: Drighlington War Cenotaph, Whitehall Road, Drighlington, Leeds, ENGLAND  
Piper Ryan Fountain - Location: Oromocto War Memorial, Oromocto, New Brunswick, CANADA  
Piper Uri Schleifer - Location: St Andrew's Scottish Church and Guesthouse, Jerusalem, ISRAEL  
Piper Steve Jackson - Location: Heighington Village War Memorial, County Durham, ENGLAND  
Piper Jamie Johnston - Location: St Albert, Alberta, CANADA  
Piper Andrew Wallace - Location: Blanefield War Memorial, Blanefield, Stirlingshire, SCOTLAND  
Piper Don McCammon - Location: County Courthouse Lawn, 200 West Broadway, Downtown Missoula, Montana, USA  
Piper Donna McCammon - Location: County Courthouse Lawn, 200 West Broadway, Downtown Missoula, Montana, USA  
Piper Graham Durant-Law - Location: Queanbeyan, New South Wales, AUSTRALIA  
Piper Donald J McRae - Location: Gourrock Cenotaph, Greenock, Renfrewshire, SCOTLAND  
Piper Alan Harrison - Location: Hereford Cathedral, Hereford, ENGLAND

Piper David Brown - Location: TBC  
Piper Hardy Spoehr - Location: Honolulu Natatorium (WW1 War Memorial), Hawaii, USA  
Piper Daniel Shane - Location: Memorial Park, Long Beach, Los Angeles, California, USA  
Piper Margaret Macbrayne - Location: Argyll, SCOTLAND  
Piper Yves Tripon - Location: Blain, Loire-Atlantique, Brittany, FRANCE  
Piper Mark David Kauder - Location: 46, Redcote Close, Southampton, Hampshire, ENGLAND  
Piper Brian A Simpson - Location: Stirling, SCOTLAND  
Piper Scott Manson - Location: Ayr War Memorial, Ayrshire, SCOTLAND  
Piper Hugh Ward - Location: Bothwell Cenotaph, Bothwell, South Lanarkshire, SCOTLAND  
Piper Daniel Guichard - Location: Saint-Jacut de la Mer, Brittany, FRANCE  
Piper Salmun Mousavi - Location: Leo Carillo State Beach, Malibu, USA  
Piper Dietmar Fahrenwald - Location: National Memorial Place, "Neue Wache", Unter den Linden, Berlin, GERMANY  
Piper David R Celebrezze - Location: Ohio, USA  
Piper David Locky - Location: TBC  
Piper Carol Jaquith - Location: Rochester, Minnesota, USA  
Piper Robert Dickie - Location: 185 Mill Road, Lanarkshire, SCOTLAND  
Piper Kinross Kebbell - Location: Peterborough Cathedral, Peterborough, Cambridgeshire, ENGLAND  
Piper Robert Keys - Location: Cenotaph, Old Glasgow Road, Uddingston, South Lanarkshire, SCOTLAND  
Piper Tony Gardiner - Location: Dayboro Cenotaph, Queensland, AUSTRALIA

Piper Gary Dickey - Location: Westlake Village, Ventura County, California, USA  
Piper Eddie Selden - Location: War Veterans Memorial, Main Street, Seabrook, Texas, USA  
Piper Petra Lage - Location: War Memorial, Sievern, Niedersachsen, GERMANY  
Piper James Buchanan - Location: Rutland, ENGLAND  
Piper Stewart Marshall - Location: Stirlingshire, SCOTLAND  
Piper Tom Gray - Location: Derby, Derbyshire, ENGLAND  
Piper Cassie Rowantree - Location: TBC  
Piper Chris Davidson - Location: Church of Our Lady, Durley, Hampshire, ENGLAND  
Piper Neil Whitehead - Location: War Memorial, Lower Hutt, NEW ZEALAND  
Piper Peter Moore - Location: NSW, AUSTRALIA  
Piper Joan MacLunny - Location: Naval Chapel, Naval Air Base, Pensacola, Florida, USA  
Piper Alister Smith - Location: Cenotaph, Maclean, New South Wales, AUSTRALIA  
Piper Alan Munro - Location: Retirement Village, Johannesburg, SOUTH AFRICA  
Piper Robert Larcom - Location: Doral, Florida, USA  
Piper David Pulled - Location: TBC  
Piper Tony Best - Location: Hinchingsbrooke House, Huntingdon, Cambridgeshire, ENGLAND  
Piper Ian A Reid - Location: 31st/42nd Battalion The Royal Queensland Regiment Soldiers Memorial, Passchendaele Lines, Lavarack Barracks, Townsville, Queensland, AUSTRALIA  
Piper Russell White - Location: TBC  
Piper Sandro Murru - Location: Mogadishu, SOMALIA





# Acknowledgements

Piper Stephen Beattie - Location: TBC  
Piper Jonathan Swan - Location: Tower of Chelmsford Cathedral, Chelmsford, ENGLAND  
Piper David Burrous - Location: TBC  
Piper Colin Dunlop - Location: TBC, NEW ZEALAND  
Piper Iain Bell - Location: Canonbie War Memorial, Dumfries & Galloway, SCOTLAND  
Piper Revd Des Plint - Location: Cenotaph, Oxford Street, East London, SOUTH AFRICA  
Piper Doug Russell - Location: Florida, USA  
Piper David Barrett - Location: Future Site of the WW1 War Memorial, Washington DC, USA  
Piper Burns Curtis - Location: Oklahoma, USA  
Piper Matt Evans - Location: Duncansville, Pennsylvania, USA  
Piper James Reid - Location: Morpeth, Northumberland, ENGLAND  
Piper Don Noakes - Location: Nanaimo, British Columbia, CANADA  
Piper Dr Elaine Marshall - Location: TBC, Edinburgh, SCOTLAND  
Piper Graeme Foster - Location: Wanganui, NEW ZEALAND  
Piper Peter Lambert - Location: War Memorial, Littlemoor, Yorkshire, ENGLAND  
Piper Christopher T Lancaster M.D. - Location: Winter Park, Florida, USA  
Piper Adrian Jameson - Location: Kings Park War Memorial, Perth, AUSTRALIA  
Piper Michael Pretsell - Location: Kings Park War Memorial, Dalkeith, Edinburgh, SCOTLAND  
Piper Andy Grant - Location: Alnwick Memorial, Northumberland, ENGLAND  
Piper John McCain - Location: Fort Worth, Texas, USA  
Piper Richard Rush - Location: Loudon Park Cemetery, Baltimore, Maryland, USA

Piper Mick Barnard - Location: TBC, Isle of Wight, ENGLAND  
Piper Alasdair Stuart - Location: Newtonmore War Memorial, Highland, SCOTLAND  
Piper Kevin York - Location: Market Place, Bishop Auckland, County Durham, ENGLAND  
Piper Ian Kinloch - Location: Dromore War Memorial, Dromore, County Down, NORTHERN IRELAND  
Piper Ian Matthews - Location: Murcia, SPAIN  
Piper Graeme Foster - Location: Whanganui, North Island, NEW ZEALAND  
Piper Steven Bathory-Peeler - Location: Franklin, Massachusetts, USA  
Piper John Dedullen - Location: Kapellen, Antwerp, BELGIUM  
Piper David Harper - Location: Norwich, Norfolk, ENGLAND  
Piper David Stark - Location: South Lanarkshire, SCOTLAND  
Piper Menez Herve - Location: Saint-Nazaire, Brittany, FRANCE  
Piper Peter Cound - Location: TBC  
Piper Oliver Calman - Location: Sydney, AUSTRALIA  
Piper John Young - Location: TBC  
Piper Sean Slater - Location: Noddfa, Olmarch, Ceredigion, WALES  
Piper David Harrington - Location: Wallace, USA  
Piper Tom Wright - Location: Willoughby, Ohio, USA  
Piper Jim Farley - Location: 62 Apollo Parade, Palmerston North 4414, NEW ZEALAND  
Piper Ron Hitchcock - Location: Regina, Saskatchewan, CANADA  
Piper Alister Smith - Location: Harwood, New South Wales, AUSTRALIA  
Piper Roger Bayes - Location: Norwich, Norfolk, ENGLAND

Piper Jacob Millin - Location: Cromer, Norfolk, ENGLAND  
Piper Andrew I MacKenzie - Location: Portsmouth, Hampshire, ENGLAND  
Piper Paddy McGowan - Location: Birmingham, West Midlands, ENGLAND  
Piper Pascal Reber - Location: Charleston, South Carolina, USA  
Piper Rory Marsden - Location: Norfolk, ENGLAND  
Piper Ian Miller - Location: Larne, County Antrim, NORTHERN IRELAND  
Piper Don Lewis - Location: TBC  
Piper Thomas McCulloch - Location: TBC  
Piper Professor Steven D. Hays - Location: Polwarth Building, Aberdeen, SCOTLAND  
Piper David Ian Weir - Location: Surbiton, Royal Borough of Kingston upon Thames, London, ENGLAND  
Piper Sam Wright - Location: FRANCE  
Piper Michael Bates - Location: East Sussex, ENGLAND  
Piper James Innes - Location: 65 Broadwood Way, Lancaster, Lancashire, ENGLAND  
Piper Halliday Mac - Location: TBC  
Piper Adrian Eaton - Location: Surrey, ENGLAND  
Piper Geoff Calvert - Location: Isle of Harris, SCOTLAND  
Piper Neill Kemp - Location: 119 Raeberry Street, Glasgow, SCOTLAND  
Piper Gilbert MacKay - Location: Okeham, 9 Glebe Lane, East Renfrewshire, SCOTLAND  
Piper Andy Wright - Location: Albert, CANADA  
Piper Don Wright - Location: AUSTRALIA  
Piper William Reed - Location: Middlesex, Massachusetts, USA  
Piper Paula Mary Howes - Location: Pudsey, Leeds, West Yorkshire, ENGLAND  
Piper Michael Shanahan - Location: Royal Hospital, Chelsea, London, ENGLAND

Piper Michael Littlejohn, 1400 Linden Avenue, Carpinteria, California, USA  
Piper Susan - Location: Norfolk, ENGLAND  
Piper Euan Mackinnon - Location: Auchterarder, Perth & Kinross, SCOTLAND  
Piper David Makin-Byrd - Location: Pennsylvania, USA  
Piper Amanda Spangenberg - Location: Hershey, PA, Pennsylvania, USA  
Piper Rab Letham - Location: 155 Godstone Road, Surrey, ENGLAND  
Piper John Johnstone - Location: 57 Main Street, Stone, West Lothian, SCOTLAND  
Piper Charles MacNeill - Location: 4 Blakelaw Road, Alnwick, Northumberland, ENGLAND  
Piper Barry Flynn - Location: AUSTRALIA  
Piper Michael McGee - Location: Arizona, USA  
Piper Catriona Hill - Location: TBC  
Piper Glenn Craig - Location: 32 Subline Point Avenue, Tascott, New South Wales, AUSTRALIA  
Piper Douglas Glover - Location: 443 Victoria Street, Ontario, CANADA  
Piper Terry Smith - Location: TBC  
Piper Brian O'Neil - Location: Kaslo, British Columbia, CANADA  
Piper Ross McNaughton. - Location: Army School of Piping, Edinburgh, SCOTLAND  
Piper Gregor MacGregor - Location: 342 East Main Street, Gaylord, Michigan, USA  
Piper Phillip Hopkins - Location: Victoria, British Columbia, CANADA  
Piper Ruth Wright - Location: 1 Northbridge Park, St Helen Auckland, County Durham, ENGLAND  
Piper Rod Caird - Location: Ipswich, Suffolk, ENGLAND  
Piper David Winkler - Location: TBC



# Acknowledgements

**Piper Duncan Brown - Location: The Lanarkshire Victoria Cross Memorial, Hamilton, Lanarkshire, SCOTLAND (Duncan Brown was responsible for the erection of the monument in Hamilton Town Square, and is dedicated to the 14 men from the County of Lanarkshire who were awarded the Victoria Cross).**

Piper Max Lloyd - Location: Bury St Edmunds, Suffolk, ENGLAND

Piper Jane MacRae - Location: Hoveton, ENGLAND

Piper Denise Ramsbottom - Location: Norwich Railway Station, Norwich, Norfolk, ENGLAND

Drummer Val Fryer - Location: Norwich Railway Station, Norwich, Norfolk, ENGLAND

Piper Steve Law - Location: Norwich Railway Station, Norwich, Norfolk, ENGLAND

Piper Tom Foster - Location: Band Stand, Pavillion Gardens, Gorleston-on-Sea, Great Yarmouth, Norfolk, ENGLAND

Piper Ian Soulsby - Location: Martham War Memorial, St Mary's Church, Martham, Norfolk, ENGLAND

Piper Ian Robertson - Location: War Memorial, Tacolneston (South Norfolk) Church, Norfolk, ENGLAND

Piper Michael Ovenden - Location: Ness Point, Lowestoft, Suffolk ENGLAND



# TMS Media - Pagemasters to the Pageantmaster



24-page brochure for Trafalgar Weekend 21-23 October 2005.



8-page menu for Trafalgar Night Dinner 21 October 2005.



8-page guide to taking part in The Great Poppy Party Weekend 10, 11, 12 June 2011.



8-page guide to taking part for The Queen's Diamond Jubilee Beacons 4 June 2012.

**Few design agencies have the privilege of working on projects of national significance.**

From celebrations to mark the 200th anniversary of the Battle of Trafalgar and the 90th anniversary of the Royal British Legion to Fly a Flag for the Commonwealth, TMS Media has had the pleasure of working with Pageantmaster Bruno Peek on events that celebrate many important milestones in our history and culture.

Much of Bruno's work has associations with historic anniversaries, for example, The Queen's Diamond Jubilee Beacons project was a high-profile televised celebration for which we designed a guide to taking part and a website for people and organisations to register events around the country.

Our creative work for the hugely successful Fly a Flag for the Commonwealth in 2013 also included a website and a guide, which has been updated to showcase some of the many exciting events that took place in its inaugural year.

We're delighted to be the Pagemasters to the Pageantmaster.

**01493 662929 [www.tms-media.co.uk](http://www.tms-media.co.uk)**

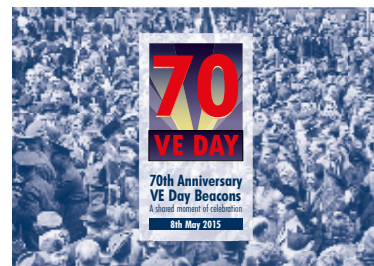

8-page guide to taking part for 70th Anniversary of VE Day 8 May 2015



8-page guide to taking part for Fly the Red Ensign for Merchant Navy Day 3 September 2015



A unique 124-page leather-bound book listing all the Beacon locations for The Queen's Diamond Jubilee Beacons was presented to The Queen 4 June 2012.

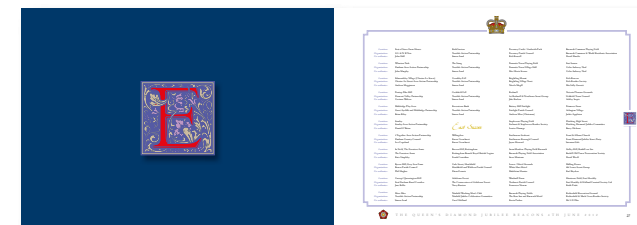

36-page guide to taking part for Fly a Flag for the Commonwealth 14 March 2016



20-page guide to taking part for The Queen's 90th Birthday Beacons 21 April 2016



# BATTLE'S OVER



A NATION'S TRIBUTE

11TH NOVEMBER 2018

100 YEARS OF REMEMBRANCE

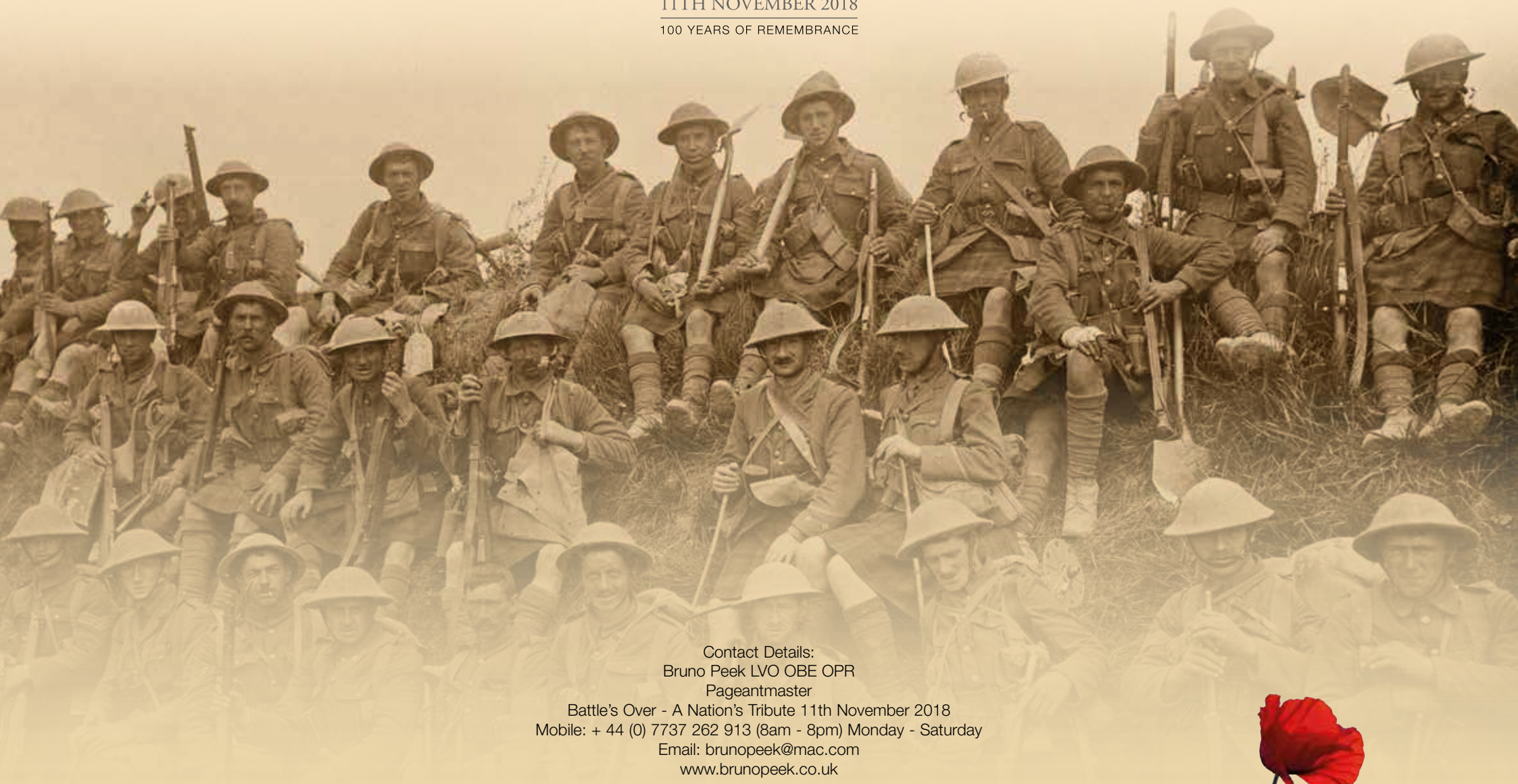

Contact Details:

Bruno Peek LVO OBE OPR

Pageantmaster

Battle's Over - A Nation's Tribute 11th November 2018

Mobile: + 44 (0) 7737 262 913 (8am - 8pm) Monday - Saturday

Email: [brunopeek@mac.com](mailto:brunopeek@mac.com)

[www.brunopeek.co.uk](http://www.brunopeek.co.uk)

